

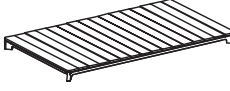





# Assembly Instruction

NO.	PICTURE	QTY
A		1PC
B		4PCS
C		4PCS
D		4PCS
E		4PCS
F		4PCS
G		4PCS
H		1PC

## STEP 1

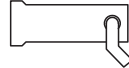
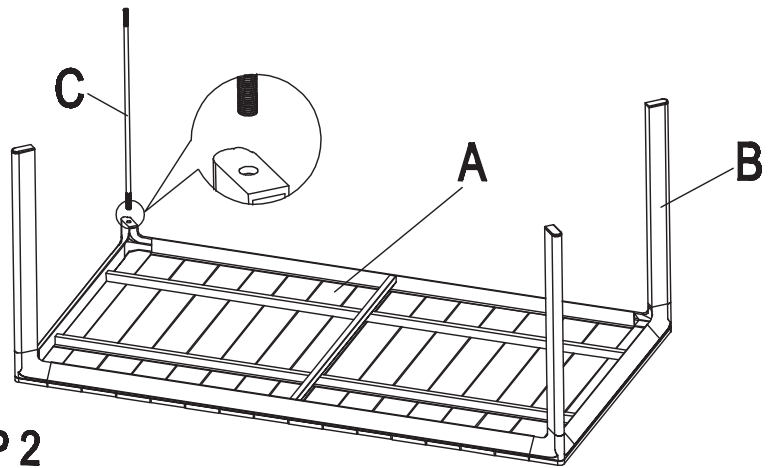

## STEP 2

