







Légende

Legend



Largeur Totale
Total width



Profondeur Totale
Total depth



Hauteur totale
Total height



Hauteur assise
Seat height



Hauteur d'accoudoir (centre)
Armrest height (centre)



Poids Net
Net weight



Diamètre de l'assise
Seat diameter



Diamètre de la base
Base diameter



Hauteur du tabouret
(Bar)Stool height



Longueur x largeur du plateau
Table top length x width



Hauteur de la table
Table height



Longueur x largeur du plateau
Table top length x width



Longueur x largeur de la base
Base length x width



Hauteur de la table
Table height



Charge maximale sur la table
Maximum table load



Diamètre de la table
Table diameter



Hauteur de la table
Table height



Longueur x largeur du plateau
Table top length x width



Longueur x largeur de la base
Base length x width



Hauteur de la table
Table height



Diamètre du plateau
Table top diameter



Diamètre de la base
Table base diameter



Hauteur de la table
Table height



Dimensions de la table pliée
Folded table measurements



Longueur de la croix
Cross length



Longueur x largeur de la base
Base length x width



Diamètre de la base
Table base diameter



Longueur de la base
Base length



Hauteur du piétement
Table base height



Hauteur du piétement
Table base height



Hauteur du piétement
Table base height



Dimensions plateau min. ou max. conseillées
Min. or max. advised table top sizes



Diamètre du tube
Tube diameter



Empilable
Stackable



Classement non-feu (+N° Norme)
Fire resistant rating (+N° Norm)



Pliable & encastrable
Foldable & stackable



Hydrofuge
Water repellent



Table pliante
Folding table



Nettoyage facile
Easy clean



Conditionnement
Packaging



Lavage Facile
Easy care



Usage extérieur
Outdoor use



Polyester recyclé
Recycled polyester



Usage intérieur uniquement
Indoor use only



Utilisation Bord de mer
Seaside use



À monter
To be assembled



Mat - Faible réflectivité
Low light reflectivity



Numéro de l'échantillon
Sample reference number



Anti-traces de doigts
Fingerprint-proof



Résistance aux UV
UV resistant



«Gestion responsable des forêts»
Forest Stewardship Council



Test de longévité sur le système pliant : 2000 cycles
Folding mechanism durability test : 2000 cycles



Produit certifié - Faibles émissions de substances chimiques - UL 2818
Product certified for low chemical emissions - UL 2818



Infos Techniques - *Technical Information*

Retrouvez l'ensemble des informations techniques en fin de catalogue.
Find all the technical information at the end of the catalog





Extérieur Outdoor

- 10-121 Assises
Seats
- 122-125 Tables
Tables
- 126-139 Piètements
Table Bases
- 140-145 Plateaux
Table Tops

Intérieur Indoor

- 148-259 Assises
Seats
- 260-265 Tables Basses
Low tables
- 266-277 Piètements
Table Bases
- 278-287 Plateaux
Table Tops
- 288-291 Meubles
Furniture

Réception Catering

- 294-295 Assises
Seats
- 296-299 Tables
Tables

Divers Miscellaneous Infos

- 302-311 Informations techniques
Technical information
- 312-315 Correspondance Pieds/Plateaux
Matching table tops and bases
- 316 Pièces détachées
Spare parts
- 318-325 Index
Index





Extérieur - Outdoor

Loom

New

Chaise - Chair



Rotin Naturel
Natural Rattan

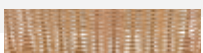





 p303



S13
R34

Structure métallique - Peinture époxy : Noir - Epaisseur tube 2mm - Diamètre tube 16mm - Tressage PE imitation rotin.
Metal frame - Powder coating : Black - Tube thickness 2mm - Tube diameter 16mm - PE wicker rattan look.

    
51 53 81 48 5,3





Loom

Loyd

New

Tabouret - *Barstool*



Rotin Naturel
Natural Rattan

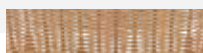

 p303



S13
R34

Structure métallique - Peinture époxy : Noir - Epaisseur tube 2mm - Diamètre tube 16mm - Tressage PE imitation rotin.
Metal frame - Powder coating : Black - Tube thickness 2mm - Tube diameter 16mm - PE wicker rattan look.



53 54 104 77 5,9





Loyd

Metz

New

Fauteuil - Armchair









Rotin Noisette
Nut Rattan



 p302-303  S4
R16

Structure en aluminium - Peinture époxy : Bamboo look caramel - Épaisseur tube 1,5mm - Diamètre tube 28mm - Tressage PE imitation rotin.

Aluminum frame - Powder coating : Caramel Bamboo look - Tube thickness 1,5mm - Tube diameter 28mm - PE wicker rattan look.

     
56 60 79 44 69 3,8

  4max



Metz

Dax

Chaise - Chair

New



STRUCTURE
FRAME

Bamboo Look Foncé
Dark Bamboo Look

New



Bamboo Look Caramel
Caramel Bamboo Look

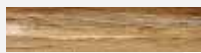

TRESSAGE
WICKER

Rotin Marron Foncé
Dark Brown Rattan

New



Rotin Noisette
Nut Rattan



ⓘ p302-303



S4,S27
R16,R27

Structure en aluminium - Peinture époxy : Bamboo look - Épaisseur tube 1,8mm - Diamètre tube 25mm - Tressage PE imitation rotin.

Aluminum frame - Powder coating : Bamboo look - Tube thickness 1,8mm - Tube diameter 25mm - PE wicker rattan look.

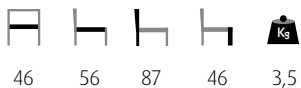

46 56 87 46 3,5



4max



Dax

Orléans

Chaise - Chair







Rotin Noisette
Nut Rattan



 p302-303  S4
R16

Structure en aluminium - Peinture époxy : Bamboo look caramel - Épaisseur tube 1,5mm - Diamètre tube 28mm - Tressage PE imitation rotin.

Aluminum frame - Powder coating : Caramel Bamboo look - Tube thickness 1,5mm - Tube diameter 28mm - PE wicker rattan look.

    
54 56 82 45 3,5





Orléans

Rochelle

Fauteuil - *Armchair*





Rotin Noisette
Nut Rattan





 p302-303  S4
R16

Structure en aluminium - Peinture époxy : Bamboo look caramel - Épaisseur tube 1,5mm - Diamètre tube 28mm - Tressage PE imitation rotin.

Aluminum frame - Powder coating : Caramel Bamboo look - Tube thickness 1,5mm - Tube diameter 28mm - PE wicker rattan look.

     
56 63 93 45 64 4

  4^{max}



Rochelle

Brest

Tabouret - *Barstool*



Rotin Noisette
Nut Rattan



 p302-303  S4
R16

Structure en aluminium - Peinture époxy : Bamboo look caramel - Épaisseur tube 1,5mm - Diamètre tube 28mm - Tressage PE imitation rotin.

Aluminum frame - Powder coating : Caramel Bamboo look - Tube thickness 1,5mm - Tube diameter 28mm - PE wicker rattan look.



36 49 45 2





Brest

Laval

Tabouret - *Barstool*



Rotin Noisette
Nut Rattan



 p302-303



S4
R16

Structure en aluminium - Peinture époxy : Bamboo look caramel - Épaisseur tube 1,5mm - Diamètre tube 28mm - Tressage PE imitation rotin.

Aluminum frame - Powder coating : Caramel Bamboo look - Tube thickness 1,5mm - Tube diameter 28mm - PE wicker rattan look.

   
36 47 76 2,7





Laval

Murcia

Fauteuil - Armchair



Taupe
Taupe

Noir
Black

Terracotta
Terracotta

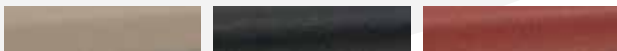

p302



S23,S24,S25
R20,R21,R22,
R23,R24,R25

Structure en aluminium - Peinture époxy - Épaisseur tube 1,35mm renforcé par tube intérieur de 1mm - Diamètre tube 25mm - Tressage corde textilène - Coussin polyester 4cm inclus, fixé par velcro.

Aluminum frame - Powder coating - Tube thickness 1,35mm reinforced by 1mm inner tube - Tube diameter 25mm - Textilene rope - Polyester cushion 4cm included, fixed by velcro.

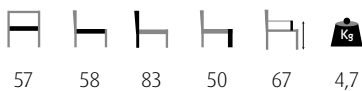

57 58 83 50 67 4,7

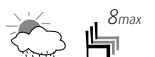



Murcia

Cadix

Ensemble - Set



Anthracite
Anthracite

 p302



S21
R17,R18

Structure en aluminium - Peinture époxy : Anthracite - Fauteuils : épaisseur tube pieds 2mm ; diamètre tube pieds 30mm -
Table : épaisseur tube 1,6mm ; diamètre tube 30mm - Corde Textilène - Coussins polyester inclus.

Aluminum frame - Powder coating : Anthracite - Armchairs : leg tube thickness 2mm ; legs tube diameter 30mm -
Table : tube thickness 1,6mm ; tube diameter 30mm - Textilene rope - Polyester cushions included.



74	73	73	45	60	9,2	Fauteuil 1 place <i>One-Seater</i>
150	73	73	45	60	15,4	Fauteuil 2 places <i>Two-Seater</i>



110x53	40	3,7	Table basse <i>Low table</i>
--------	----	-----	--------------------------------





Cadix

Denia

New

Fauteuil - Armchair



Terra



Sable



 p303



S29,S30
R29,R30

Structure en aluminium - Peinture époxy - Épaisseur tube 1,3mm - Diamètre tube 32mm - Tressage PE rond effet corde.
Aluminum frame - Powder coating - Tube thickness 1,3mm - Tube diameter 32mm - Round PE rope look.

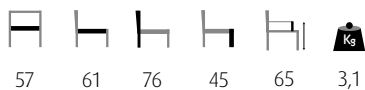

ISO 4892-3:2016 Cycle 1
ISO 105-A02:1993/Cor.2:2005



Denia

Alicante

New

Tabouret - *Barstool*



Terra
Terra

Sable
Sand

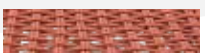





 p303



S29,S30
R29,R30

Structure en aluminium - Peinture époxy - Épaisseur tube 1,3mm - Diamètre tube 32mm - Tressage PE rond effet corde.
Aluminum frame - Powder coating - Tube thickness 1,3mm - Tube diameter 32mm - Round PE rope look.

54 57 106 75 3,3



ISO 4892-3:2016 Cycle 1
ISO 105-A02:1993/Cor.2:2005



Alicante

Javea

New

Fauteuil - Armchair



Paille
Straw



 p303



S1+R1

Structure en acier - Peinture époxy : Anthracite - Epaisseur tube 1,4mm - Diamètre tube 19mm - Tressage PE torsadé 5mm.
Steel frame - Powder coating : Anthracite - Tube thickness 1,4mm - Tube diameter 19mm - Twisted PE rattan 5mm.

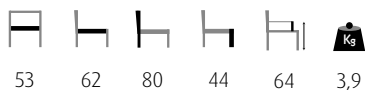



Javea

Amsterdam

Fauteuil - *Armchair*



Paille
Straw



Olive
Olive



Anthracite
Anthracite









 p303



S1+R1
S1+R2
S1+R3

Structure en aluminium - Peinture époxy : Anthracite - Épaisseur tube 32x1,2mm à 19x2mm - Tressage PE torsadé 5mm.
Aluminum frame - Powder coating : Anthracite - Tube thickness 32x1,2mm to 19x2mm - Twisted PE Rattan 5mm.

     
57 58 77 46 65 3,1





Amsterdam

Breda

Tabouret - Barstool



Paille
Straw



Olive
Olive



Anthracite
Anthracite



 p303



S1+R1
S1+R2
S1+R3

Structure en aluminium - Peinture époxy : Anthracite - Épaisseur tube 32x1,2mm à 19x2mm - Tressage PE torsadé 5mm.
Aluminum frame - Powder coating : Anthracite - Tube thickness 32x1,2mm to 19x2mm - Twisted PE Rattan 5mm.

46 58 104 76 3,2





Breda

Savana

Stock
Limité
Limited
Stock

Fauteuil - Armchair



Paille
Straw

Olive
Olive

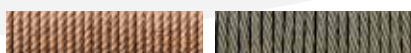

 p303



S1+R1
S1+R2

Structure en acier - Peinture époxy : Anthracite - Épaisseur tube 1mm - Diamètre tube 22mm - Tressage PE torsadé 5mm.
Steel frame - Powder coating : Anthracite - Tube thickness 1mm - Tube diameter 22mm - Twisted PE rattan 5mm.

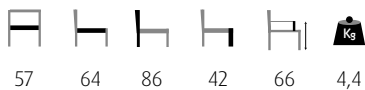



Savana

Saint-Raphaël

New

Fauteuil - Armchair



Anthracite
Anthracite

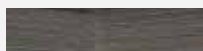

 p303



S26
R26

Structure en aluminium - Peinture époxy : Anthracite - Épaisseur tube avant 38x17x1,2mm; tube arrière 25x1,5mm - Tressage TPU rond effet corde.

Aluminum frame - Powder coating : Anthracite - Tube thickness: front 38x17x1,2mm; rear tube 25x1,5mm - Round TPU wicker rope look.

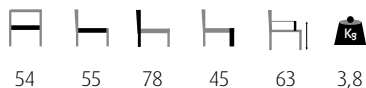

  
ASTM G154-23



Saint-Raphaël

Concorde

Stock
Limité
Limited
Stock

Fauteuil - *Armchair*

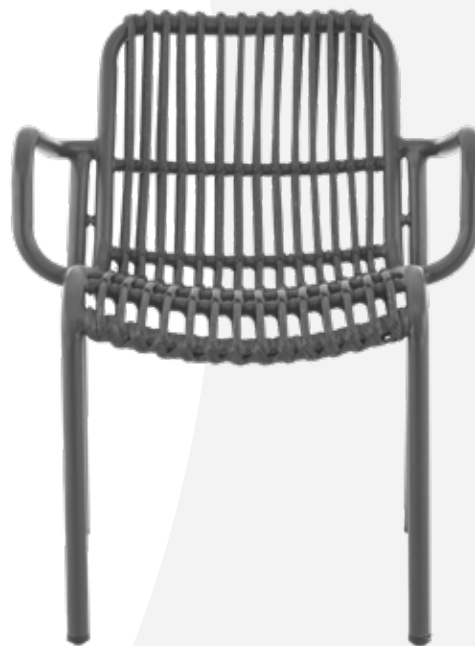

Anthracite
Anthracite



 p302

Structure en aluminium - Peinture époxy : Anthracite - Épaisseur tube 1,5mm - Diamètre tube 28mm - Corde textilène anthracite.
Aluminum frame - Powder coating : Anthracite - Tube thickness 1,5mm - Tube diameter 28mm - Anthracite textilene rope.

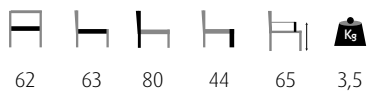



Concorde

Odéon

New

Chaise - Chair



Crème & Vert
Cream & Green

Blanc & Camel
White & Camel



 p302



S31
R31,R32

Structure en aluminium - Peinture époxy : Bamboo look clair - Épaisseur tube 1,5mm - Diamètre tube 28mm - Textilène 8x8.
Aluminum frame - Powder coating : Light Bamboo look - Tube thickness 1,5mm - Tube diameter 28mm - Textilene 8x8.



6max



Odéon

Bercy

New

Fauteuil - Armchair



Crème & Vert
Cream & Green

Blanc & Camel
White & Camel



 p302



S31
R31,R32

Structure en aluminium - Peinture époxy : Bamboo look clair - Épaisseur tube 1,5mm -Diamètre tube 28mm - Textilène 8x8.
Aluminum frame - Powder coating : Light bamboo look - Tube thickness 1,5mm - Tube diameter 28mm - Textilene 8x8.





Bercy

Limoges

New

Chaise - Chair



Gris & Blanc
Grey & White



 p302



S5
R28

Structure en aluminium - Peinture époxy : Bamboo look clair - Épaisseur tube 1,5mm - Diamètre tube 28mm - Textilène 8x8.
Aluminum frame - Powder coating : Light bamboo look - Tube thickness 1,5mm - Tube diameter 28mm - Textilene 8x8.



51 59 86 46 4





Limoges

Reims

Chaise - Chair





Gris & Beige
Grey & Beige



 p302  S22
R19

Structure en aluminium - Peinture époxy : Bamboo look chestnut - Épaisseur tube 1,5mm - Diamètre tube 28mm - Textilène 4x4.
Aluminum frame - Powder coating : Bamboo look chestnut- Tube thickness 1,5mm - Tube diameter 28mm - Textilene 4x4.

    
49 55 85 47 3

  6max



Reims

Blois

Fauteuil - Armchair



Gris & Beige
Grey & Beige



 p302



S22
R19

Structure en aluminium - Peinture époxy : Bamboo look chestnut - Tube avant : épaisseur 2mm ; diamètre 24mm -
Tube arrière : épaisseur 1,5mm ; diamètre 28mm - Textilène 4x4.

Aluminum frame - Powder coating : Bamboo look chestnut - Front tube : thickness 2mm ; diameter 24mm - Rear tube :
thickness 1,5mm ; diameter 28mm - Textilene 4x4.

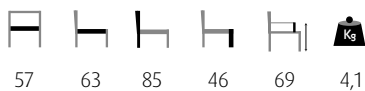



Blois

Dole

Tabouret - Barstool



Gris & Beige
Grey & Beige







 p302



S22
R19

Structure en aluminium - Peinture époxy : Bamboo look chestnut - Épaisseur tube 1,5mm - Diamètre tube 28mm - Textilène 4x4.
Aluminum frame - Powder coating : Bamboo look chestnut - Tube thickness 1,5mm - Tube diameter 28mm - Textilene 4x4.

   
45 60 76 2,9





Dole

Paris

Chaise - Chair

New



STRUCTURE
FRAME

Bamboo Look Clair
Light Bamboo Look

New



Bamboo Look Foncé
Dark Bamboo Look



TRESSAGE
WICKER

Noir & Blanc
Black & White

New



Noir
Black



Bordeaux & Crème
Bordeaux & Cream



Vert & Crème
Green & Cream



i p302



S32,S6
R33,R13,R14,R15

Structure en aluminium - Peinture époxy : Bamboo look - Épaisseur tube 1,5mm - Diamètre tube 28mm - Textilène 8x8.
Aluminum frame - Powder coating : Bamboo look - Tube thickness 1,5mm - Tube diameter 28mm - Textilene 8x8.

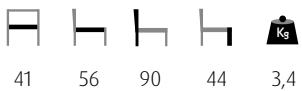



Paris

Montmartre

Fauteuil - *Armchair*



Noir
Black



 p302



S6
R13

Structure en aluminium - Peinture époxy : Bamboo look foncé - Épaisseur tube 1,5mm - Diamètre tube 28mm - Textilène 8x8.
Aluminum frame - Powder coating : Dark Bamboo look - Tube thickness 1,5mm - Tube diameter 28mm - Textilene 8x8.

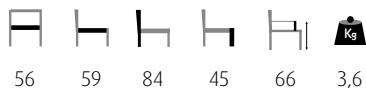

56 59 84 45 66 3,6





Montmartre

Drouot

Stock
Limité
Limited
Stock

Chaise - Chair



Noir & Gris Clair
Black & Light Grey



 p302



S2
R11

Structure aluminium - Peinture époxy : Noir - Épaisseur tube 1,5mm - Diamètre tube 28mm - Textilène 8x8.
Aluminum frame - Powder coating : Black - Tube thickness 1,5mm - Tube diameter 28mm - Textilene 8x8.

47 58 88 46 3,5





Drouot

Trocadero

Fauteuil - Armchair



Noir & Gris Clair
Black & Light Grey



 p302



S2
R11

Structure aluminium - Peinture époxy : Noir - Épaisseur tube 1,5mm - Diamètre tube 28mm - Textilène 8x8.
Aluminum frame - Powder coating : Black - Tube thickness 1,5mm - Tube diameter 28mm - Textilene 8x8.

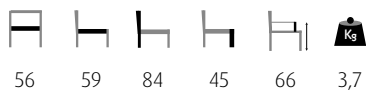



Trocadero

Villette

Stock
Limité
Limited
Stock

Chaise - Chair



Noir
Black



 p302-303



S5
R9

Structure en aluminium - Peinture époxy : Bamboo look clair - Épaisseur tube 1,5mm - Diamètre tube 28mm - Tressage PE.
Aluminum frame - Powder coating : Light Bamboo look - Tube thickness 1,5mm - Tube diameter 28mm - PE Wicker.

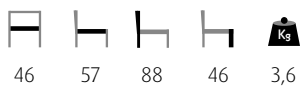



Villette

Madeleine

Stock
Limité
Limited
Stock

Fauteuil - *Armchair*



Noir
Black



 p302-303



S5
R9

Structure en aluminium - Peinture époxy : Bamboo look clair - Épaisseur tube 1,5mm - Diamètre tube 28mm - Tressage PE.
Aluminum frame - Powder coating : Light Bamboo look - Tube thickness 1,5mm - Tube diameter 28mm - PE wicker.

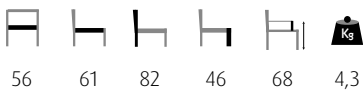



Madeline

Dauphine

Stock
Limité
Limited
Stock

Fauteuil - *Armchair*



Noir
Black

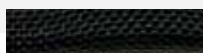

 p302



S2
R4

Structure aluminium - Peinture époxy : Noir - Tube avant 28x1,35mm et tube arrière 25x1,35mm - Textilène 2x2.
Aluminum frame - Powder coating : Black - Front tube 28x1,35mm and rear tube 25x1,35mm - Textilene 2X2.

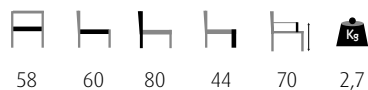



Dauphine

Bastille

Chaise - Chair



Terra
Terra

 Sauge
Sage

 Anthracite
Anthracite



 p302



S33,S34,S7

Structure en acier - Peinture époxy - Effet texturé - Épaisseur tube 1,5mm - Diamètre tube 22mm.
Steel frame - Powder coating - Textured effect - Tube thickness 1,5mm - Tube diameter 22mm.

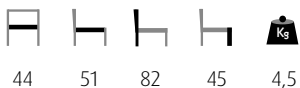

  
ISO 4892-3:2016



Bastille

Bastille Bst

Tabouret - Barstool



New



Terra
Terra

New Sauge
Sage

New Anthracite
Anthracite



i p302



S33,S34,S7

Structure en acier - Peinture époxy - Effet texturé - Épaisseur tube 1,5mm - Diamètre tube 22mm.
Steel frame - Powder coating - Textured effect - Tube thickness 1,5mm - Tube diameter 22mm.



53 56 96 75 6,7

UV  
ISO 4892-3:2016 δ_{max}



Bastille Bst

Pigalle

Table - Table

New



New

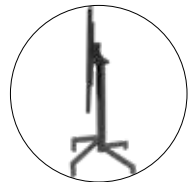

Terra
Terra

New Sauge
Sage

New Anthracite
Anthracite



i p303



S33,S34,S7

Pied de table en aluminium - Encastrable - Système basculant - Plateau en tôle d'acier - Peinture époxy - Effet texturé.
Aluminum table base - Stackable - Folding mechanism - Steel sheet table top - Powder coating - Textured effect.



60x60 42x42 75,5 41x103 8



2000 cycles



Pigalle

Doha

New

Fauteuil Lounge - Lounge Armchair



Anthracite
Anthracite

Taupe
Taupe

Sauge
Sage

Terra
Terra



p303



S17,S18
S19,S20

Monobloc polypropylène
Polypropylene monobloc

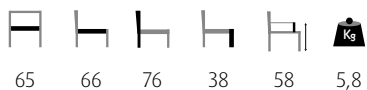



Doha

Cairo

New

Table Basse - *Low table*



Anthracite
Anthracite

Taupe
Taupe

Saugé
Sage

Terra
Terra



p303



S17,S18
S19,S20

Polypropylène - Vérins de réglage.
Polypropylene - Adjustable footplugs.



44x43 47x45 41 2,6 70





Cairo

Dubai

Chaise - Chair



Anthracite
Anthracite

Taupe
Taupe

Sauge
Sage

Terra
Terra



 p303  S17,S18
S19,S20

Monobloc polypropylène.
Polypropylene monobloc.

    
51 57 78 45 4,2



Dubai

Jeddah

Fauteuil - *Armchair*



Anthracite
Anthracite

Taupe
Taupe

Sauge
Sauge

Terra
Terra



 p303



S17,S18
S19,S20

Monobloc polypropylène.
Polypropylene monobloc.





Jeddah

Oman

Tabouret - *Barstool*



Anthracite
Anthracite

Taupe
Taupe

Sauge
Sage

Terra
Terra



 p303



S17,S18
S19,S20

Monobloc polypropylène.
Polypropylene monobloc.





Oman

Penelope

Chaise - Chair



Noir
Black



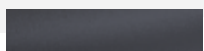

Marsala
Marsala



 p303



Monobloc polypropylène renforcé avec fibre de verre.
Polypropylene monobloc reinforced with fiberglass.

    
50 59 84 47 4,2

CATAS
Test report
343113





Penelope

Ulysse

Fauteuil - Armchair



Noir
Black

Marsala
Marsala



 p303



Monobloc polypropylène renforcé avec fibre de verre.
Polypropylene monobloc reinforced with fiberglass.

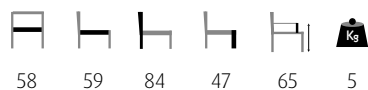

58 59 84 47 65 5

CATAS
Test report
343116





Ulysse

Achille Bar 75

New

Tabouret - Barstool



Noir
Black

Marsala
Marsala



 p303



Monobloc polypropylène renforcé avec fibre de verre.
Polypropylene monobloc reinforced with fiberglass.



53 55 105 75 5,5

CATAS
Test report
363230





Achille Bar 75

Tom Bar 75

Tabouret - Barstool



Noir
Black

Marsala
Marsala

Olive
Olive



 p303



Polypropylène renforcé avec fibre de verre.
Polypropylene reinforced with fiberglass.



34 42 75 4

CATAS
Test report
344047





Tom Bar 75

Monna

Chaise - Chair



Noir
Black



Olive
Olive



Octane
Octane



Moutarde
Mustard



 p303



Monobloc polypropylène renforcé avec fibre de verre.
Polypropylene monobloc reinforced with fiberglass.

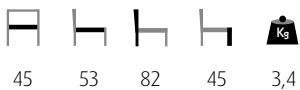

CATAS
Test report
276554





Monna

Sky Pro

Fauteuil - Armchair



Noir
Black

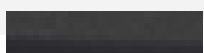

Olive
Olive



 p303



Monobloc polypropylène renforcé avec fibre de verre.
Polypropylene monobloc reinforced with fiberglass.

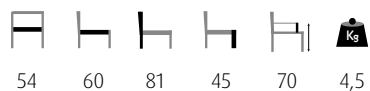

CATAS
Test report
326232





Sky Pro

Maya

Chaise - *Chair*



Noir
Black



Olive
Olive



Gris Foncé
Dark Grey



Blanc
White

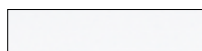

 p303



Monobloc polypropylène.
Polypropylene monobloc.

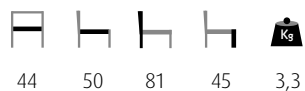

CATAS
Test report
73610





Maya

Maya Bar 75

Tabouret - Barstool



Noir
Black



Olive
Olive



Gris Foncé
Dark Grey



Blanc
White



 p303



Monobloc polypropylène.
Polypropylene monobloc.



44 51 108 75 5,7

CATAS
Test report
236234





Maya Bar 75

Atlantic

Fauteuil - *Armchair*



Noir
Black



 p303



Monobloc polypropylène renforcé avec fibre de verre - Textilène Serge Ferrari 2x2.
Polypropylene monobloc reinforced with fiberglass - Serge Ferrari Textilene 2x2.

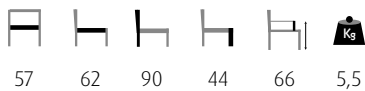

 Serge Ferrari

 CATAS

Test report
308018





Atlantic

Marcel

Chaise - Chair



Noir

Black

 p303



Monobloc polypropylène renforcé avec fibre de verre.
Polypropylene monobloc reinforced with fiberglass.



45 52 85 44 3,5

CATAS
Test report
294903





Marcel

Marcel XL

Fauteuil - *Armchair*









Noir
Black

 p303



Monobloc polypropylène renforcé avec fibre de verre.
Polypropylene monobloc reinforced with fiberglass.

					
57	52	85	44	68	3,9

CATAS
Test report
294887





Marcel XL

Marcel Bar 75

Tabouret - Barstool



Noir
Black



 p303



Polypropylène renforcé avec fibre de verre.
Polypropylene reinforced with fiberglass.



45 52 106 75 4,7

CATAS
Test report
294883





Marcel Bar 75

Daytona

Chaise - Chair







Gris Foncé
Dark Grey

 p303



Monobloc polypropylène renforcé avec fibre de verre - Imitation rotin.
Polypropylene monobloc reinforced with fiberglass - Rattan look.

    
53 60 82 46 3,5

CATAS
Test report
201747





Daytona

Panama

Fauteuil - *Armchair*



Gris Foncé
Dark Grey

 p303



Monobloc polypropylène renforcé avec fibre de verre - Imitation rotin.
Polypropylene monobloc reinforced with fiberglass - Rattan look.



57 61 81 46 72 4,3

CATAS
Test report
201753





Panama

Jamaica

Chaise - Chair



Gris Foncé
Dark Grey

 p303



Monobloc polypropylène renforcé avec fibre de verre - Imitation rotin.
Polypropylene monobloc reinforced with fiberglass - Rattan look.

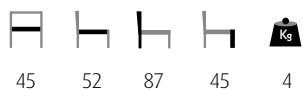

45 52 87 45 4

CATAS
Test report
144188





Jamaica

Jamaica F

Fauteuil - *Armchair*



Gris Foncé
Dark Grey

 p303



Monobloc polypropylène renforcé avec fibre de verre - Imitation rotin.
Polypropylene monobloc reinforced with fiberglass - Rattan look.

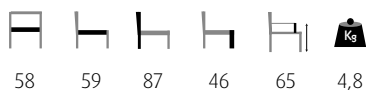

CATAS
Test report
127165





Jamaica F

Jamaica Bst

Tabouret - Barstool



Gris Foncé
Dark Grey

 p303



Monobloc polypropylène renforcé avec fibre de verre - Imitation rotin.
Polypropylene monobloc reinforced with fiberglass - Rattan look.

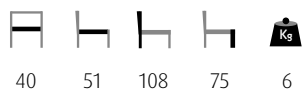

CATAS
Test report
157230





Jamaica Bst

Kys

Table - Table







Noir
Black



 p303



Résine renforcée par une structure métallique - Encastrable - Système basculant - Vérins de réglage.
Resin reinforced by a metallic frame - Stackable - Fliptop mechanism - Adjustable foot plugs.

   
60x60 74 47x100 7,3





Kys

Kys Bar

Table haute - *High table*



Noir
Black



 p303



Résine renforcée par une structure métallique - Encastrable - Système basculant - Vérins de réglage.
Resin reinforced by a metallic frame - Stackable - Fliptop mechanism - Adjustable foot plugs.



60x60 108 47x134 7,5





Kys Bar

Modena New

Pied de table - *Table base*

Système basculant - *Fliptop mechanism*



Poignée: Facile à porter.
Handle: Easy to carry.



2 crochets pour suspendre les sacs.
2 hooks for hanging bags.



Encastrable: Facile à ranger.
Stackable: Easy to store.



Modena Double: Facile à basculer.
Modena double: Easy to flip.



Modena 3



Modena Double

Noir Mat
Matt Black



S13

Base et tube en aluminium - Peinture époxy - Système basculant en polyamide - Vérins de réglage - Anneau antivol (sauf Modena Double).

Aluminum Base and tube - Powder coating - Polyamide fliptop mechanism - Adjustable footplugs - Anti-theft ring (except Modena Double).



ISO 9227:2022

Modena 3

58	72	Ø60 mm	Ø60	4,6	1,5

Contrepoids
Extraveight
Kg

Modena Double

95x50	72	Ø60 mm	100x60	120x80	7,1

New

Modena

Pied de table - Table base

Système antivol - Anti-theft mechanism



Anneau antivol en PVC.
PVC anti-theft ring.

ACCESSOIRES



Câble vrillé avec fils d'acier de Ø4 mm recouverts d'une gaine PVC. Longueurs disponibles : 6 ou 9 m.
Twisted cable with Ø4 mm steel wires covered by a PVC sheath. Available lengths : 6 or 9 m.



Cadenas à 4 chiffres (37x13x44mm)
4-digit padlock



Modena 4



Modena 4 Bar



S11,S13

Anthracite*
Anthracite*

Noir Mat
Matt Black

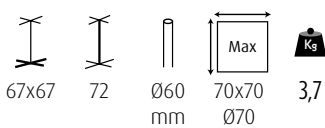

Modena 4

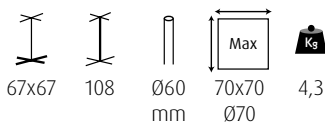

Modena 4 Bar

Base et tube en aluminium - Peinture époxy - Système basculant en polyamide - Vérins de réglage - Anneau antivol.
Aluminum Base and tube - Powder coating - Polyamide fliptop mechanism - Adjustable footplugs - Anti-theft ring.

*Uniquement pour Modena 4 & Modena 4 Bar.
*Only for Modena 4 & Modena 4 Bar.

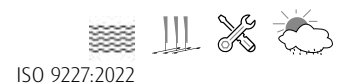

Kyoto

New

Pied de table - Table base



Kyoto 4



Kyoto 4 Bar

Noir Mat
Matt Black



S13

Base et tube en aluminium - Peinture époxy - Système basculant
Système autostabilisant - Anneau antivol - Contre-poids.

Aluminum Base and tube - Powder coating - Polyamide fliptop
mechanism - Self-stabilizing system - Anti-theft ring - Extra weight.

Kyoto 4



68x68



72

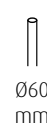

Ø60
mm



Max
80x80
Ø100



6,7

Contrepoids
Extraweight
Kg

2,5

Kyoto 4 Bar

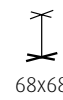

68x68



108

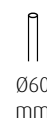

Ø60
mm



Max
70x70
Ø70



7,3

Contrepoids
Extraweight
Kg

2,5



ISO 9227:2022

New

Kyoto

Pied de table - Table base

Piètements autostabilisants - Self-stabilizing tables bases



Système hydraulique **autostabilisant** permettant d'assurer la stabilité des tables en compensant les différences de niveau de sol jusqu'à 12mm.

Self-leveling hydraulic system to ensure table stability by compensating for ground surface differences up to 12mm.



Avant
Before



Après
After

Contre-poids - Extra-weight



Contre-poids de 2,5kg intégré.
Integrated 2,5kg extra-weight.

Système basculant - Fliptop mechanism



Poignée: Facile à porter.
Handle: Easy to carry.



2 crochets pour suspendre les sacs.
2 hooks for hanging bags.



Encastrable: Facile à ranger.
Stackable: Easy to store.

Système antivol - Anti-theft mechanism



Anneau antivol en PVC.
PVC anti-theft ring.

ACCESSOIRES



Câble vrillé avec fils d'acier de Ø4 mm recouverts d'une gaine PVC. Longueurs disponibles : 6 ou 9 m.
Twisted cable with Ø4 mm steel wires covered by a PVC sheath. Available lengths : 6 or 9 m.



Cadenas à 4 chiffres (37x13x44mm)
4-digit padlock

Monza

Pied de table - *Table base*



Monza



Monza Bar

Anthracite
Anthracite



S11

Base et tube en aluminium - Peinture époxy - Vérins de réglage.
Aluminium base and tube - Powder coating - Adjustable footplugs.



ISO 9227:2017

Monza

63x63	73	Ø60 mm	Max 70x70 Ø70	4	1,5

Monza Bar

63x63	108	Ø60 mm	Max 60x60 Ø70	5,8	3



Monza

Berlin

Pied de table - *Table base*



Berlin 2



Berlin 4

Noir
Black



S13

Base et tube en aluminium - Peinture époxy - Vérins de réglage.
Aluminium base and tube - Powder coating - Adjustable footplugs.



ISO 9227:2017

Berlin 2



60x68



73

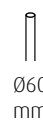

Ø60
mm



100x60



120x80



4,5

Berlin 4



66x66



73

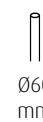

Ø60
mm

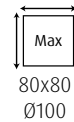

80x80
Ø100



6,1

Contrepoids
Extraweight
Kg

1,5

Berlin

Pied de table - *Table base*



Berlin 4 Bar

					Contreponds Extraweight Kg
66x66	108	Ø60 mm	70x70 Ø70	6,6	3

Berlin 4 Bar



S13

Noir
Black



Base et tube en aluminium - Peinture époxy - Vérins de réglage.
Aluminium base and tube - Powder coating - Adjustable footplugs.



ISO 9227:2017

Empire

Pied de table - *Table base*



Empire 3



Empire 4



Empire 4 Bar

Noir
Black



S12

Aluminium forgé noir - Peinture époxy - Vérins de réglage.
Cast aluminum - Powder coating - Adjustable footplugs.



Empire 3			
Empire 4			
Empire 4 Bar			

Empire

Pied de table - *Table base*



Empire 2



Empire Grande

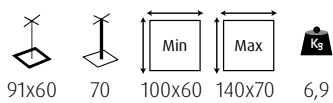

Empire 2



S12

Noir
Black



Aluminium forgé noir - Peinture époxy - Vérins de réglage.
Cast aluminum - Powder coating - Adjustable footplugs.

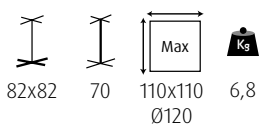

Empire Grande



Bistrot

Pied de table - *Table base*



Bistrot 3 H43



Bistrot 3

Noir
Black



S15

Fonte d'acier* - Epoxy noir - Vérins de réglage.
Cast iron* - Powder coated in black - Adjustable footplugs.



⚠ *Ces articles peuvent rouiller en utilisation extérieure.
*These items may rust when used outdoor.

Bistrot 3 H43

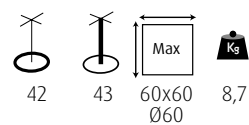

Bistrot 3

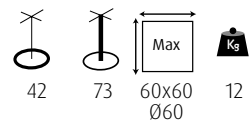

Bistrot

Pied de table - *Table base*



Bistrot 4



Bistrot 3 Bar

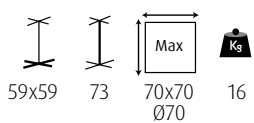

Bistrot 4

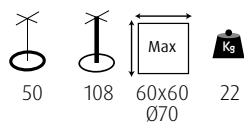

Bistrot 3 Bar



S15

Noir
Black



Fonte d'acier* - Epoxy noir - Vérins de réglage.
Cast iron* - Powder coated in black - Adjustable footplugs.



*Ces articles peuvent rouiller en utilisation extérieure. ⚠️
*These items may rust when used outdoor.

Orsay

New

Table - Table

⚠ Table complète : pied & plateau ne peuvent être vendus séparément.
Complete table : base & top cannot be sold separately.



PLATEAU
TOP

Marbre Blanc - Laiton
White Marble - Brass



PIED
BASE

Noir
Black



Pied en fonte d'acier* - Système basculant - Plateau diamètre 60cm et épaisseur 30mm : plateau compact 5mm imitation marbre et contreplaqué mélaminé 22mm - Cerclage doré en acier inoxydable 201 galvanisé - Vérins de réglage.

Cast iron base* - Folding mechanism - Top diameter 60cm and thickness 30mm : 5mm HPL top with 22mm melamine plywood - Golden galvanized stainless steel 201 ring - Adjustable foot plugs.

60 46 75 106x37 16,6

⚠ *Cet article peut rouiller en utilisation extérieure.
*This item may rust when used outdoor.





Orsay

Compact Easy 12mm

New

Plateau de table - Table top

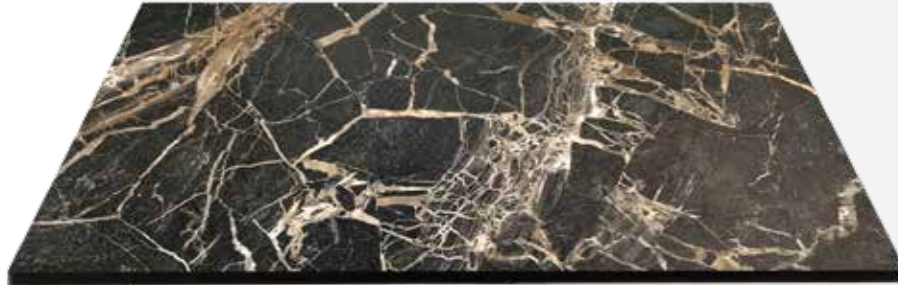

Alaska Oak
694

New



Black Meteor
11

New



Padova
804

New

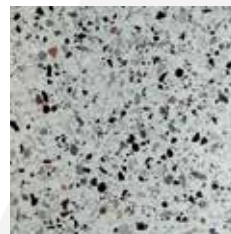

Terrazzo
669

New



Marmo Griggio
671



Grafito
918



Slate
658



Corten
406

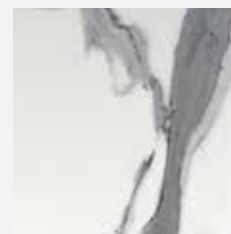

Marmo Bianco
654



Colorado
459

	
cm	65x65
12 mm	5,8kg

Plateau compact 12mm - Chants droits - Système de fixation universel (visserie fournie) - Protection UV.

12mm HPL top - Straight edges - Universal fixing system (screws included) - UV resistant.



Compact
Easy

⚠ Risque de décoloration des couleurs foncées au soleil.
Risk of dark colors fading if sun exposure.

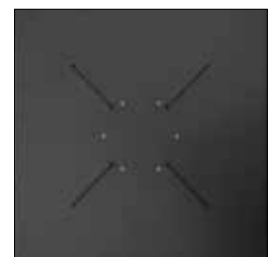

Inserts pour Verona + rails pour autre système de fixation en croix.

Inserts for Verona + grooves for other cross fixing systems.



Compact Easy

Stratifié Moulé Classic

New

Plateau de table - *Table top*



Basalt
5810

New



Hausmann
4723

New



Granit Light
5807

New



Avalon Pine
4729

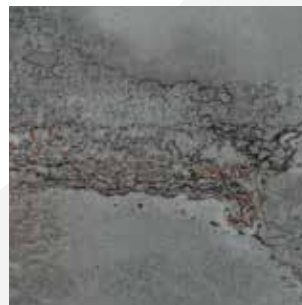

Irony
9687

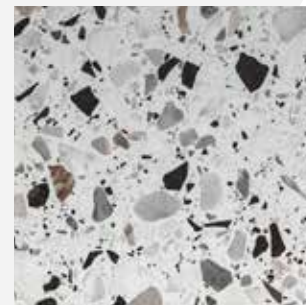

Malaga
5766

	□		○
cm	60x60	70x70	Ø60
32 mm	5,9kg	8kg	5,3kg

Plateau stratifié moulé - Chant 32mm.

Molded laminated top - 32mm edges.



⚠ Risque de décoloration des couleurs foncées au soleil.
Risk of dark colors fading if sun exposure.





Stratifié Moulé Classic

Stratifié Moulé Cerclé

Plateau de table - *Table top*



Marrakesh
5717



Mermer
5410

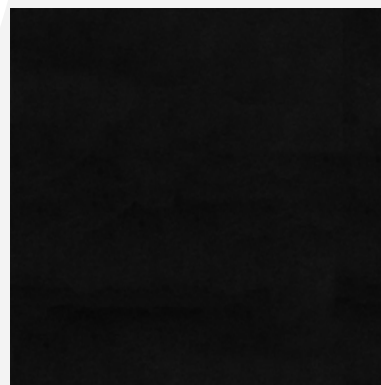

Black Siyah
3190



Laiton
Brass

	○
cm	Ø60
30 mm	4,9kg

Plateau stratifié moulé - Cerclage métallique finition laiton - Chant 30mm.
Rimmed table top - Brass finish metal band - 30mm edges.



⚠ Risque de décoloration des couleurs foncées au soleil.
Risk of dark colors fading if sun exposure.





Stratifié Moulé Cerclé





Intérieur - Indoor

Eloïse

New

Chaise - Chair



Greige 05
Greige 05

Terra 56
Terra 56

Vert 75
Green 75

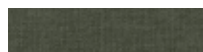
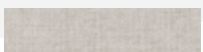

 p306

DAVIS
Wind

ABRASION TEST
30.000-40.000

BS 5852/0
EN 1021/1

Structure en hêtre teinté noir - Assise et dos garnis de tissu WIND.
Black stained beech frame - Seat and back upholstered with WIND fabric.

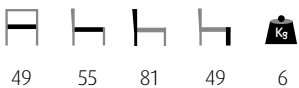

49 55 81 49 6





Eloïse

Romeo

New

Fauteuil - Armchair



Greige 05
Greige 05

Terra 56
Terra 56

Vert 75
Green 75

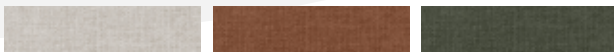

 p306

DAVIS
Wind

ABRASION TEST
30.000-40.000

BS 5852/0
EN 1021/1

Structure en hêtre teinté noir - Assise et dos garnis de tissu WIND.
Black stained beech frame - Seat and back upholstered with WIND fabric.

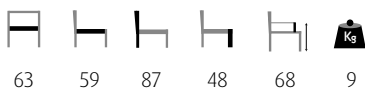



Romeo

Tristan Bst

New

Tabouret - Barstool



Greige 05
Greige 05

Terra 56
Terra 56

Vert 75
Green 75



 p306

DAVIS
Wind

ABRASION TEST
30.000-40.000

BS 5852/0
EN 1021/1

Structure en hêtre teinté noir - Assise et dos garnis de tissu WIND - Repose-pieds en hêtre avec renfort métallique.
Black stained beech frame - Seat and back upholstered with WIND fabric - Beech footrest with metal reinforcement.



52 57 105 77 9





Tristan Bst

Clothilde

New

Chaufeuse - Lounge chair



Greige 05
Greige 05

Terra 56
Terra 56

Vert 75
Green 75

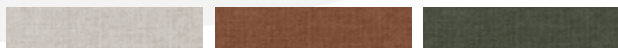





 p306

DAVIS
Wind

ABRASION TEST
30.000-40.000

BS 5852/0
EN 1021/1

Structure en hêtre teinté noir - Assise et dos garnis de tissu WIND.
Black stained beech frame - Seat and back upholstered with WIND fabric.

    
70 72 78 43 13,3





Clothilde

Ginette

New

Chaise - Chair



Greige 05
Greige 05

Gris Foncé 88
Dark Grey 88



 p306

DAVIS
Sorella

ABRASION TEST
60.000-70.000

BS 5852/0
EN 1021/1

Structure en hêtre teinte noire - Assise et dos garnis de tissu SORELLA.
Black stained beech frame - Seat and back upholstered with SORELLA fabric.

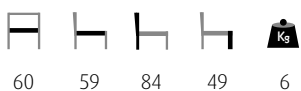

60 59 84 49 6





Ginette

Angèle

New

Chaise - Chair



Greige 05
Greige 05

Gris Foncé 88
Dark Grey 88



 p306

DAVIS
Sorella

ABRASION TEST
60.000-70.000

BS 5852/0
EN 1021/1

Structure en hêtre teinté noir - Assise et dos garnis de tissu SORELLA.
Black stained beech frame - Seat and back upholstered with SORELLA fabric.



55 56 77 50 7





Angèle

Marius Bst

New

Tabouret - Barstool



Greige 05
Greige 05

Gris Foncé 88
Dark Grey 88



 p306

DAVIS
Sorella

ABRASION TEST
60.000-70.000

BS 5852/0
EN 1021/1

Structure en hêtre teinté noir - Assise et dos garnis de tissu SORELLA - Repose-pieds en hêtre avec renfort métallique.
Black stained beech frame - Seat and back upholstered with SORELLA fabric - Beech footrest with metal reinforcement.



52 57 105 77 9





Marius Bst

Eugénie

New

Chaufeuse - Lounge chair



Greige 05
Greige 05

Gris Foncé 88
Dark Grey 88



 p306

DAVIS
Sorella

ABRASION TEST
60.000-70.000

BS 5852/0
EN 1021/1

Structure en hêtre teinté noir - Assise et dos garnis de tissu SORELLA.
Black stained beech frame - Seat and back upholstered with SORELLA fabric.

    
70 72 78 43 13,3





Eugénie

Simone

Chaise - Chair



Vert 39
Green 39



Terra 59
Terra 59



Gris Clair 83
Light Grey 83



 p307

DAVIS
Aragon

ABRASION TEST
45.000-60.000

BS 5852/0
EN 1021/1

WATER
REPELLENT

Structure en métal noir - Épaisseur tube 1,8mm - Diamètre tube 16mm - Assise et dossier garnis de tissu ARAGON.
Black metal frame - Tube thickness 1,8mm - Tube diameter 16mm - Upholstered seat and back with ARAGON fabric.

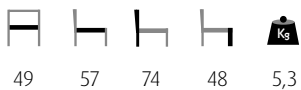

49 57 74 48 5,3





Simone

René

Fauteuil - Armchair



Vert 39
Green 39



Terra 59
Terra 59



Gris Clair 83
Light Grey 83



i p307

DAVIS
Aragon

ABRASION TEST
45.000-60.000

BS 5852/0
EN 1021/1



Structure en métal noir - Épaisseur tube 1,8mm - Diamètre tube 16mm - Assise et dossier garnis de tissu ARAGON.
Black metal frame - Tube thickness 1,8mm - Tube diameter 16mm - Upholstered seat and back with ARAGON fabric.

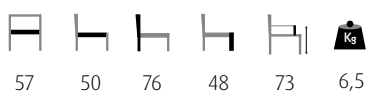



René

Auguste

Tabouret - *Barstool*



Vert 39
Green 39

Terra 59
Terra 59

Gris Clair 83
Light Grey 83



 p307





DAVIS
Aragon

ABRASION TEST
45.000-60.000

BS 5852/0
EN 1021/1



Structure en métal noir - Épaisseur tube 2mm - Diamètre tube 19mm - Assise et dossier garnis de tissu ARAGON.
Black metal frame - Tube thickness 2mm - Tube diameter 19mm - Upholstered seat and back with ARAGON fabric.

    
51 55 108 78 8,4





Auguste

Mélina

Chaise - Chair



Gris 18
Grey 18



 p307

DAVIS
Gava

ABRASION TEST
>100.000

BS 5852/0
EN 1021/1

WATER
REPELLENT

RECYCLED
POLYESTER

Structure en métal noir - Épaisseur tube 1,5mm - Diamètre tube 19mm - Assise et dossier garnis de tissu GAVA.
Black metal frame - Tube thickness 1,5mm - Tube diameter 19mm - Upholstered seat and back with GAVA fabric.

    
55 58 75 48 5,4





Mélina

Sandra

Tabouret - Barstool



Gris 18
Grey 18



 p307

DAVIS
Gava

ABRASION TEST
>100.000

BS 5852/0
EN 1021/1

WATER
REPELLENT

RECYCLED
POLYESTER

Structure en métal noir - Épaisseur tube 1,5mm - Diamètre tube 19mm - Assise et dossier garnis de tissu GAVA.
Black metal frame - Tube thickness 1,5mm - Tube diameter 19mm - Upholstered seat and back with GAVA fabric.

    
53 56 104 79 6





Sandra

Noëlia

Chaise - Chair



Gris 10/Noir
Grey 10/Black



 p308

fab
Brego

ABRASION TEST
30.000

Structure en métal noir - Épaisseur tube: dossier 1,8mm/pieds 2,5mm - Diamètre tube 16mm - Assise garnie de tissu BREGO - Dossier en contre-plaqué, garni en PVC imitation cannage naturel.

Black metal frame - Tube thickness: back 1,8mm/legs 2,5mm - Diameter tube 16mm - Seat upholstered in BREGO fabric - Plywood backrest with PVC imitation natural caning.

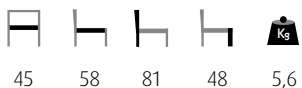

45 58 81 48 5,6





Noëlia

Zoé

Chaise - Chair

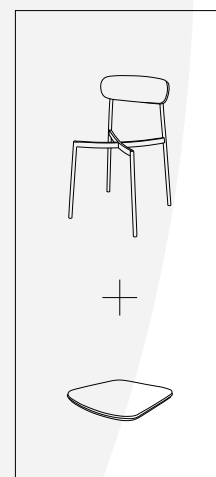

STRUCTURE - FRAME

Noir & Bois Naturel
Black & Natural Wood



Blanc & Bois Naturel
White & Natural Wood

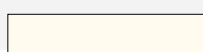

ASSISE - SEAT

Gris Brun 056
Grey Brown 056



Olive 144
Olive 144



Orange 106
Orange 106



Beige 032
Beige 032



p308

Miss

ABRASION TEST
>40.000

Structure en métal - Épaisseur tube 2mm - Diamètre tube 19mm - Assise en contre-plaqué, garnie de tissu MISS - Dossier en contre-plaqué.

Metal frame - Tube thickness 2mm - Tube diameter 19mm - Plywood seat upholstered in MISS fabric - Plywood back.

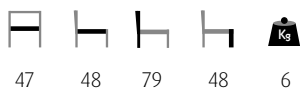

47 48 79 48 6





Zoé

Ralph

Tabouret - *Barstool*

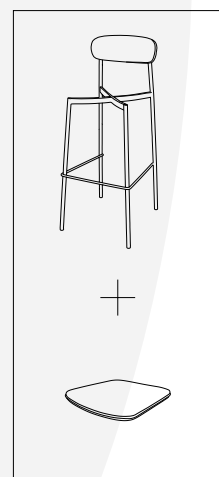

STRUCTURE - FRAME

Noir & Bois Naturel
Black & Natural Wood



Blanc & Bois Naturel
White & Natural Wood

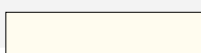

ASSISE - SEAT

Gris Brun 056
Grey Brown 056



Olive 144
Olive 144



Orange 106
Orange 106



Beige 032
Beige 032



p308

Miss

ABRASION TEST
>40.000

Structure en métal - Épaisseur tube 2mm - Diamètre tube 19mm - Assise en contre-plaqué, garnie de tissu MISS - Dossier en contre-plaqué.

Metal frame - Tube thickness 2mm - Tube diameter 19mm - Plywood seat upholstered in MISS fabric - Plywood back.

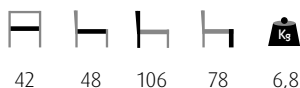

42 48 106 78 6,8





Ralph

Mikka

Chaise - Chair



Cuoio
Cuoio

Anthracite
Anthracite



 p308

 **elastron**
COLORADO

ABRASION TEST
100.000

 **BS 5852/0**
EN 1021/1



Structure en métal noir - Épaisseur tube 1,5mm - Diamètre tube 32mm - Assise et dossier garnis de similicuir PU COLORADO.
Black metal frame - Tube thickness 1,5mm - Tube diameter 32mm - Seat and back upholstered in COLORADO PU faux-leather.

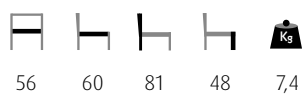



Mikka

Olaf

Fauteuil - Armchair



Cuoio
Cuoio



Anthracite
Anthracite



p308

elastron
COLORADO

ABRASION TEST
100.000

BS 5852/0
EN 1021/1



Structure en métal noir - Épaisseur tube 1,5mm - Diamètre tube 32mm - Assise et dossier garnis de similicuir PU COLORADO.
Black metal frame - Tube thickness 1,5mm - Tube diameter 32mm - Seat and back upholstered in COLORADO PU faux-leather.

Kg
57 59 87 48 66 6,8





Olaf

Jacob

Chaise - Chair



Cuoio
Cuoio

Anthracite
Anthracite



 p308

 **elastron**
COLORADO

ABRASION TEST
100.000

 **BS 5852/0**
EN 1021/1

 **EASY CARE**

Structure en métal noir - Épaisseur tube 1,5mm - Tube 15x30mm - Assise et dossier garnis de similicuir PU COLORADO.
Black metal frame - Tube thickness 1,5mm - Tube 15x30mm - Seat and back upholstered in COLORADO PU faux-leather.

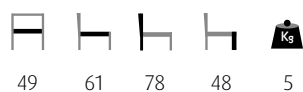



Jacob

Kyle

Tabouret - Barstool



Cuoio
Cuoio

Anthracite
Anthracite



p308

elastron
COLORADO

ABRASION TEST
100.000

BS 5852/0
EN 1021/1



Structure en métal noir - Épaisseur tube 1,5mm - Tube 19x30mm - Assise et dossier garnis de similicuir PU COLORADO.
Black metal frame - Tube thickness 1,5mm - Tube 19x30mm - Seat and back upholstered in COLORADO PU faux-leather.

46 53 106 78 6,1





Kyle

Wendy

Banquette - Bench



Connecteur amovible inclus
Removable connector included



Cuoio
Cuoio

Anthracite
Anthracite



 p308

 **elastron**
COLORADO

ABRASION TEST
100.000

 **BS 5852/0**
EN 1021/1



Structure en métal noir - Épaisseur tube 1,5mm - Tube 30x30mm - Assise et dossier garnis de similicuir PU COLORADO.
Black metal frame - Tube thickness 1,5mm - Tube 30x30mm - Seat and back upholstered in COLORADO PU faux-leather.

     
120 60 94 48 30





Wendy

Maurice

Chaise - Chair



Cognac
Cognac

Anthracite
Anthracite

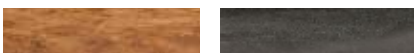

EN 1021:1/2

Structure métallique noire - Épaisseur tube 1,5mm - Diamètre tube 28mm - Assise et dos garnis en similicuir PU.
Black metal frame - Tube thickness 1,5mm - Tube diameter 28mm - Seat and back upholstered with PU faux-leather.

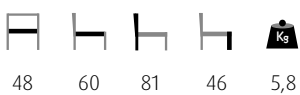



Maurice

Maurice Bst

Tabouret - Barstool



Maurice Bst H65

Maurice Bst H79

Cognac
Cognac



Anthracite
Anthracite



EN 1021:1/2

Structure métallique noire - Épaisseur tube 1,5mm - Diamètre tube 28mm - Assise et dos garnis en similicuir PU.
Black metal frame - Tube thickness 1,5mm - Tube diameter 28mm - Seat and back upholstered with PU faux-leather.



37 50 92 65 6,3 Maurice Bst H65

37 54 107 79 6,8 Maurice Bst H79





Maurice Bst

College

Chaise - Chair



Teinte Brun Vintage
Vintage Brown Stain



Structure en métal finition industrielle, vernis brillant - Épaisseur tube 1,5mm - Diamètre tube 25mm - Assise et dossier en contre-plaqué.

Metal frame industrial finish, glossy varnish - Tube thickness 1,5mm - Tube diameter 25mm - Seat and back in plywood.

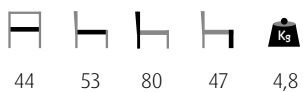

44 53 80 47 4,8





College

Harvard

New

Tabouret - *Barstool*



Teinte Brun Vintage
Vintage Brown Stain



Structure en métal finition industrielle, vernis brillant - Épaisseur tube 1,5mm - Diamètre tube 25mm - Assise et dossier en contre-plaqué.

Metal frame industrial finish, glossy varnish - Tube thickness 1,5mm - Tube diameter 25mm - Seat and back in plywood.

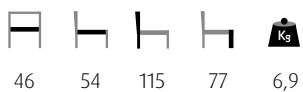

46 54 115 77 6,9





Harvard

Montreal

Fauteuil - Armchair



Marron Vintage
Vintage Brown



Structure en métal noir - Épaisseur tube 40x20x1,2mm - Assise et dossier garnis de similicuir PU.
Black metal frame - Tube thickness 40x20x1,2mm - Seat and back upholstered with PU faux-leather.



52 55 77 46 68 7,5





Montreal

Stanley

Chaise - Chair



Marron Vintage
Vintage Brown

Structure métallique noire - Épaisseur tube 1,5mm - Diamètre tube 19mm - Assise et dos garnis en similicuir PU.
Black metal frame - Tube thickness 1,5mm - Tube diameter 19mm - Seat and back upholstered with PU faux-leather.

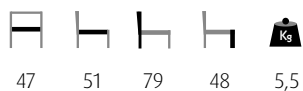



Stanley

Stanley Bst

Tabouret - Barstool



Marron Vintage
Vintage Brown



Structure métallique noire - Épaisseur tube 1,5mm - Diamètre tube 19mm - Assise et dos garnis en similicuir PU.
Black metal frame - Tube thickness 1,5mm - Tube diameter 19mm - Seat and back upholstered with PU faux-leather.





Stanley Bst

Brixton

Fauteuil - *Armchair*



Marron Vintage
Vintage Brown



Structure métallique noire - Accoudoirs en bois - Épaisseur tube 2mm - Diamètre tube 28mm - Assise et dos garnis en similicuir PU.

Black metal frame - Wooden armrests - Tube thickness 2mm - Tube diameter 28mm - Seat and back upholstered with PU faux-leather.

65	78	91	44	65	18,5	





Brixton

Soho

Chaise - Chair



Cognac Vintage
Vintage Cognac

Structure métallique noire - Épaisseur tube 1,5mm - Diamètre tube 30mm - Assise et dos garnis en similicuir PU.
Black metal frame - Tube thickness 1,5mm - Tube diameter 30mm - Seat and back upholstered with PU faux-leather.

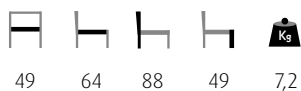



Soho

Condor

Stock
Limité
Limited
Stock

Fauteuil - *Armchair*







Cognac
Cognac

Anthracite
Anthracite



 p299

Structure métallique noire (en une pièce) - Épaisseur tube 1,2mm - Tube 20x20mm - Assise et dos garnis de tissu SOFTYL.
Black metal frame (in one piece) - Tube thickness 1,2mm - Tube 20x20mm - Seat and back upholstered with SOFTYL fabric.

51 62 91 48 65 9





Condor

Cuba

Fauteuil - *Armchair*



Brun Clair 41
Light Brown 41



 p308

fab[®]
Cortes

ABRASION TEST
35.000

Structure en hêtre teinté Wengé - Assise et dos garnis de tissu Vintage CORTES.
Wenge stained beech frame - Seat and back upholstered with CORTES vintage fabric.

72 69 70 43 67 16,8





Cuba

Cuba Double

Fauteuil - Armchair



Brun Clair 41
Light Brown 41



 p308

fabb
Cortes

ABRASION TEST
35.000

Structure en hêtre teinté Wengé - Assise et dos garnis de tissu Vintage CORTES.
Wenge stained beech frame - Seat and back upholstered with CORTES vintage fabric.

119 69 70 43 67 22,3





Cuba Double

Kate

Chaise - Chair

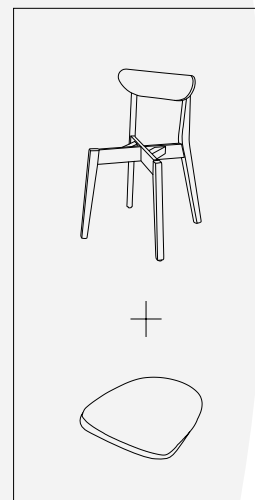

STRUCTURE - FRAME

Teinte Chêne Miel
Honey Oak Stain



Noir
Black



ASSISE - SEAT

Rouille 52
Rusty 52



Gris 90
Grey 90



Vert 34
Green 34



Bleu 75
Blue 75



DAVIS
Luis

ABRASION TEST
30.000

EN 1021/1
BS 5852/0

WATER REPELLENT

Structure en hêtre teinté - Assise garnie de tissu LUIS.
Stained beech frame - Upholstered seat with LUIS fabric.

44 48 76 49 5,1





Kate

Budapest

Chaise - Chair

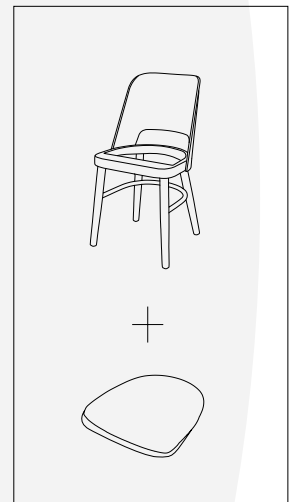

STRUCTURE - FRAME
Teinte Chêne Miel
Honey Oak Stain



Bordeaux 5269
Bordeaux 5269

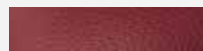

Cappuccino 5582
Cappuccino 5582

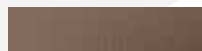

Olive 9430
Olive 9430

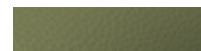

Teinte Wengé
Wenge Stain

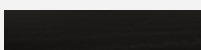

ASSISE - SEAT
Éléphant 5272
Elephant 5272



Terra 9244
Terra 9244



Noir 7006
Black 7006



p309 **TEXTUM ABRASION TEST**
Lotos >100.000

Structure en hêtre teinté - Assise garnie de similicuir PU LOTOS.
Stained beech frame - Upholstered seat with LOTOS PU faux-leather.

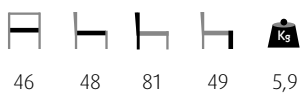



Budapest

Budapest Bst

Tabouret - Barstool

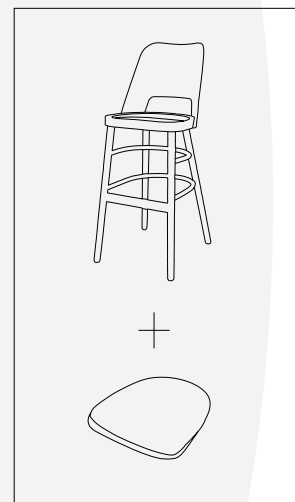

STRUCTURE - FRAME	Teinte Chêne Miel Honey Oak Stain	Bordeaux 5269 Bordeaux 5269	Cappuccino 5582 Cappuccino 5582	Olive 9430 Olive 9430
	Teinte Wengé Wenge Stain	Éléphant 5272 Elephant 5272	Terra 9244 Terra 9244	Noir 7006 Black 7006

ABRASION TEST
Lotos >100.000

Structure en hêtre teinté - Assise garnie de similicuir PU LOTOS - Repose-pieds en hêtre avec renfort métallique.
Stained beech frame - Upholstered seat with LOTOS PU faux-leather - Beech footrest with metal reinforcement.





Budapest Bst

Dimitri

Chaise - Chair

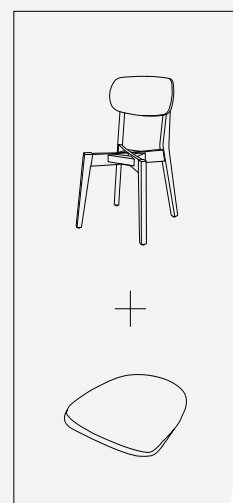

STRUCTURE - FRAME

Teinte Chêne Miel
Honey Oak Stain



ASSISE - SEAT

Noir 7006
Black 7006



 p309

 **ABRASION TEST**
Lotos >100.000

Structure en hêtre teinté - Assise garnie de similicuir PU LOTOS.
Stained beech frame - Upholstered seat with LOTOS PU faux-leather.

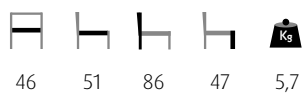



Dimitri

Dimitri Bst

Tabouret - Barstool

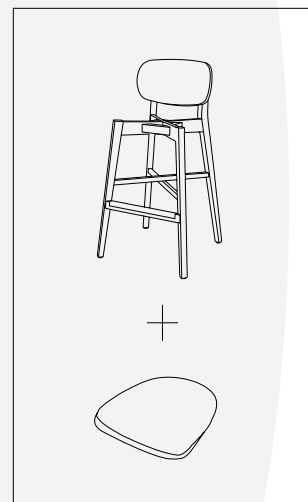

STRUCTURE - FRAME

Teinte Chêne Miel
Honey Oak Stain



ASSISE - SEAT





Noir 7006
Black 7006



 p309

 **ABRASION TEST**
Lotos >100.000

Structure en hêtre teinté - Assise garnie de similicuir PU LOTOS - Repose-pieds en hêtre avec renfort métallique.
Stained beech frame - Upholstered seat with LOTOS PU faux-leather - Beech footrest with metal reinforcement.

     
50 49 102 77 7,4





Dimitri Bst

Brooklyn

Chaise - Chair

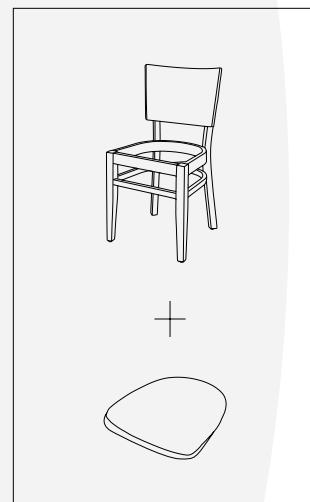

STRUCTURE - FRAME

Teinte Wengé
Wenge Stain

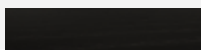

Bordeaux 5269
Bordeaux 5269

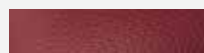

Cappuccino 5582
Cappuccino 5582



ASSISE - SEAT

Chocolat 9314
Chocolate 9314



Noir 7006
Black 7006



p309

ABRASION TEST
Lotos >100.000

Structure en hêtre teinté - Assise garnie de similicuir PU LOTOS.
Stained beech frame - Upholstered seat with LOTOS PU faux-leather.

Kg
43 53 85 47 8,6





Brooklyn

Brooklyn Bst

Tabouret - Barstool

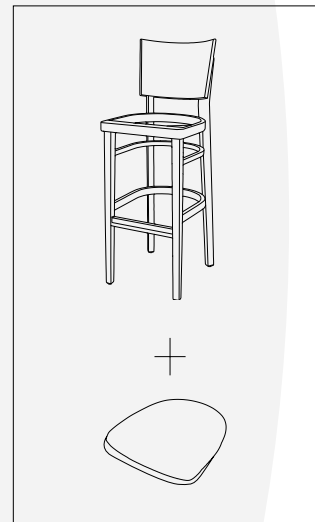

STRUCTURE - FRAME

Teinte Wengé
Wenge Stain

Bordeaux 5269
Bordeaux 5269



Cappuccino 5582
Cappuccino 5582



ASSISE - SEAT

Chocolat 9314
Chocolate 9314



Noir 7006
Black 7006



p309

ABRASION TEST
Lotos >100.000

Structure en hêtre teinté - Assise garnie de similicuir PU LOTOS - Repose-pieds en hêtre avec renfort métallique noir.
Stained beech frame - Upholstered seat with LOTOS PU faux-leather - Beech footrest with black metal reinforcement.





Brooklyn Bst

Pub

Chaise - Chair

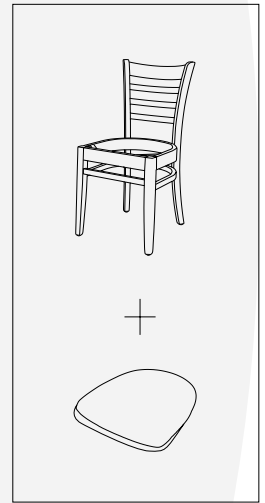

STRUCTURE - FRAME

Teinte Wengé
Wenge Stain

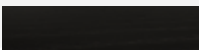

Bordeaux 5269
Bordeaux 5269



Cappuccino 5582
Cappuccino 5582



ASSISE - SEAT

Chocolat 9314
Chocolate 9314



Noir 7006
Black 7006



p309

ABRASION TEST
Lotos >100.000

Structure en hêtre teinté - Assise garnie de similicuir PU LOTOS.
Stained beech frame - Upholstered seat with LOTOS PU faux-leather.



43 53 85 47 6,9





Pub

Pub Bst

Tabouret - Barstool

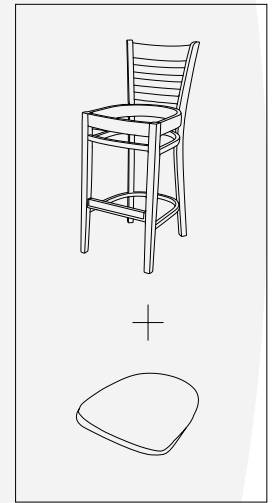

STRUCTURE - FRAME

Teinte Wengé
Wenge Stain

Bordeaux 5269
Bordeaux 5269



Cappuccino 5582
Cappuccino 5582



ASSISE - SEAT

Chocolat 9314
Chocolate 9314



Noir 7006
Black 7006



p309

ABRASION TEST
Lotos >100.000

Structure en hêtre teinté - Assise garnie de similicuir PU LOTOS - Repose-pieds en hêtre avec renfort métallique noir.
Stained beech frame - Upholstered seat with LOTOS PU faux-leather - Beech footrest with black metal reinforcement.





Pub Bst

Palma

New

Chaise - Chair



Brun Foncé
Dark Brown

Structure en hêtre teinté.
Stained beech frame.

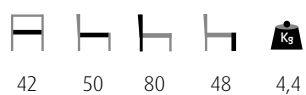



Palma

Palma Bst

New

Tabouret - Barstool



Brun Foncé
Dark Brown

Structure en hêtre teinté.
Stained beech frame.

41 43 105 75 5,5





Palma Bst

Sofia

Chaise - Chair



Noir
Black

Brun Foncé
Dark Brown

French Patina
French Patina

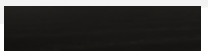

Structure en hêtre teinté.
Stained beech frame.



46 45 87 47 4





Sofia

Sofia Bst

Tabouret - Barstool



Noir
Black

Brun Foncé
Dark Brown

French Patina
French Patina



Structure en hêtre teinté.
Stained beech frame.



46 45 108 76 5,3





Sofia Bst

Emile

Chaise - Chair



Anthracite 92
Anthracite 92

Petrol 76
Petrol 76

Olive 38
Olive 38

Gold 48
Gold 48

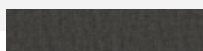

 p307

DAVIS
Monolith

ABRASION TEST
>100.000

EN 1021/1
BS 5852/0

WATER
REPELLENT

Structure en hêtre teinté noir - Assise et dossier garnis de velours MONOLITH.
Black stained beech frame - Seat and back upholstered with MONOLITH velvet.



49 55 81 49 6





Emile

Alfonse

Fauteuil - *Armchair*



Anthracite 92
Anthracite 92

Petrol 76
Petrol 76

Olive 38
Olive 38

Gold 48
Gold 48



p307

DAVIS
Monolith

ABRASION TEST
>100.000

EN 1021/1
BS 5852/0

WATER
REPELLENT

Structure en hêtre teinté noir - Assise et dossier garnis de velours MONOLITH.
Black stained beech frame - Seat and back upholstered with MONOLITH velvet.

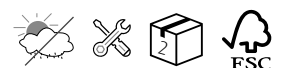
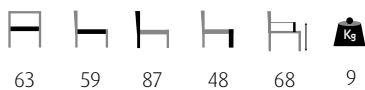



Alfonse

Oscar Bst

Tabouret - Barstool



Anthracite 92
Anthracite 92

Petrol 76
Petrol 76

Olive 38
Olive 38

Gold 48
Gold 48



DAVIS
Monolith

ABRASION TEST
>100.000

EN 1021/1
BS 5852/0



Structure en hêtre teinté noir - Assise et dos garnis de velours MONOLITH - Repose-pieds en hêtre avec renfort métallique.
Black stained beech frame - Seat and back upholstered with MONOLITH velvet - Beech footrest with metal reinforcement.





Oscar Bst

Lautrec S

Stock
Limité
Limited
Stock

Chaqueuse - Lounge Chair



Anthracite 92
Anthracite 92

Petrol 76
Petrol 76

Olive 38
Olive 38

Gold 48
Gold 48



 p307

DAVIS
Monolith

ABRASION TEST
>100.000

EN 1021/1
BS 5852/0

WATER
REPELLENT

Structure en hêtre teinté noir - Assise et dossier garnis de velours MONOLITH.
Black stained beech frame - Seat and back upholstered with MONOLITH velvet.

    
64 70 76 43 10,4





Lautrec S

Arnold

Fauteuil - *Armchair*



Anthracite 92
Anthracite 92

Petrol 76
Petrol 76

Gold 48
Gold 48



 p307

DAVIS
Monolith

ABRASION TEST
>100.000

EN 1021/1
BS 5852/0

WATER
REPELLENT

Structure en hêtre - Pieds métalliques noirs - Assise et dossier garnis de velours MONOLITH.
Beech frame - Black metal legs - Seat and back upholstered with MONOLITH velvet.

     
78 84 83 49 64 27,5

 
4 pieds à visser
4 legs to be mounted



Arnold

Willy

Fauteuil - *Armchair*



Anthracite 92
Anthracite 92

Petrol 76
Petrol 76

Gold 48
Gold 48



 p307







DAVIS
Monolith

ABRASION TEST
>100.000

EN 1021/1
BS 5852/0

WATER
REPELLENT

Structure en hêtre - Pieds métalliques noirs - Assise et dossier garnis de velours MONOLITH.
Beech frame - Black metal legs - Seat and back upholstered with MONOLITH velvet.

     
140 84 83 49 64 39

 
4 pieds à visser
4 legs to be mounted



Willy

Floriane II

Chaise - Chair



Taupe 926
Taupe 926

Chocolat 928
Chocolate 928

Noir 9100
Black 9100



 p309

Structure en hêtre teinté Wengé - Assise et dossier garnis de similicuir PU.
Wenge stained beech frame - Seat and back upholstered with PU faux-leather.





Floriane II

Floriane Bst II

Tabouret - *Barstool*



Taupe 926
Taupe 926

Chocolat 928
Chocolate 928

Noir 9100
Black 9100



 p309

Structure en hêtre teinté Wengé - Assise et dossier garnis de similicuir PU - Repose-pieds en métal.
Wenge stained beech frame - Seat and back upholstered with PU faux-leather - Metal footrest.

45 54 111 78 8,5





Floriane Bst II

Clinton

Chaise - Chair





Naturel & Éléphant 5272 Wengé & Noir 7006 Wengé & Pepper 5271
Natural & Elephant 5272 Wenge & Black 7006 Wenge & Pepper 5271



 p309  **ABRASION TEST**
Lotos >100.000

Structure en hêtre teinté - Assise et dossier garnis de similicuir PU LOTOS.
Stained beech frame - Seat and back upholstered with LOTOS PU faux-leather.

    
44 59 89 50 5,8

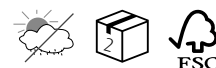



Clinton

Clinton Bst

Tabouret - Barstool



Naturel & Éléphant 5272 Wengé & Noir 7006 Wengé & Pepper 5271
Natural & Elephant 5272 Wenge & Black 7006 Wenge & Pepper 5271



 p309  **ABRASION TEST**
Lotos >100.000

Structure en hêtre teinté - Assise et dossier garnis de similicuir PU LOTOS - Repose-pieds en métal.
Stained beech frame - Seat and back upholstered with LOTOS PU faux-leather - Metal footrest.



36 44 100 81 7





Clinton Bst

Maryne

Table basse - *Low table*



Marbre noir
Black marble

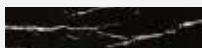

Lot de 2 tables - Structure métallique noire - Épaisseur tube 1,5mm - Diamètre tube 25mm - Plateau mélaminé.
Set of 2 tables - Black metal frame - Tube thickness 1,5mm - Tube diameter 25mm - Melamine top.



Grande/Big A: 90 / B: 80
Petite/Small A: 69 / B: 62



Grande/Big: 37
Petite/Small: 30



Grande/Big: 8,3
Petite/Small: 5,3





Maryne

Jolyne

Table basse - *Low table*



Noir
Black

Mango
Mango



Structure métallique noire - Epaisseur de tube 1,5mm - Tube 15x60mm - Plateau mélaminé - Patins réglables.
Black metal frame - Tube thickness 1,5mm - Tube 15x60mm - Melamine top - Adjustable footplugs.

  
60 42 9,5





Jolyne

Ellen

Table basse - *Low table*



Naturel
Natural



Structure métallique noire - Épaisseur tube 1,2mm - Tube 60x15mm - Plateau mélaminé - Patins réglables.
Black metal frame - Tube thickness 1,2mm - Tube 60x15mm - Melamine top - Adjustable footplugs.

  
60 43 11,7





Ellen

Gallia

New

Pied de table - *Table base*



Gallia 4



Gallia 4 Bar

Noir
Black



S15

Base et tube en fonte d'acier - Peinture époxy - Vérins de réglage.
Cast ironed base and tube - Powder coating - Adjustable footplugs.



Gallia 4

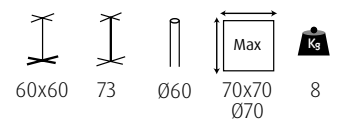

Gallia 4 Bar

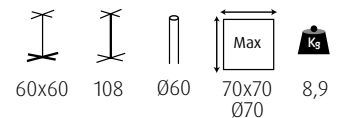

New

Gallia

Pied de table - Table base



Gallia 4 XL



Gallia Double

Noir
Black



S15

					Gallia 4 XL
76x76	73	Ø60	Max 90x90 Ø120	11,2	

						Gallia Double
60	73	Ø60	Min 90x70	Max 140x80	12,5	

Base et tube en fonte d'acier - Peinture époxy - Vérins de réglage.
Cast ironed base and tube - Powder coating - Adjustable footplugs.



Factory

Stock
Limité
Limited
Stock

Pied de table - *Table base*

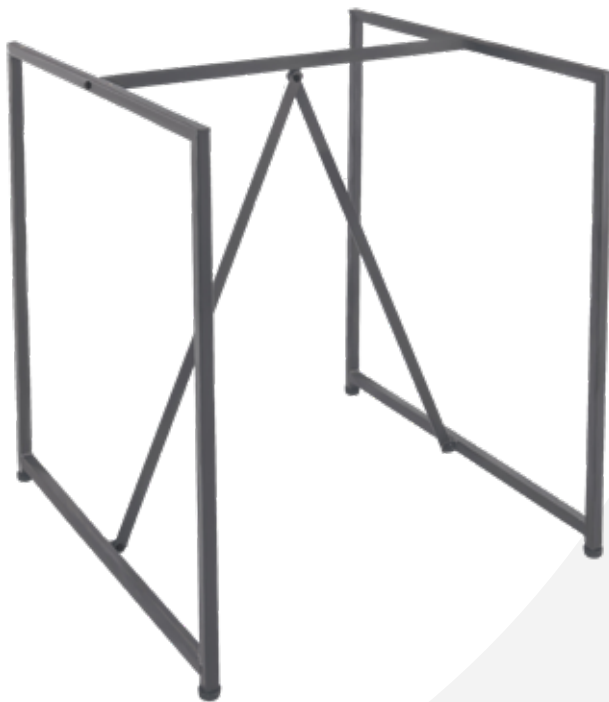

Gun Métal
Gun Metal



S15

Structure métallique - Tube 20x20mm - Épaisseur 2mm - Vérins réglables.

Metal frame - Tube size 20x20mm - Tube thickness 2mm - Adjustable footplugs.



Factory 70

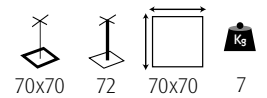

Retro

Pied de table - *Table base*



Retro Small



Retro Large

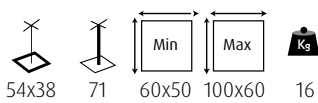

Retro Small

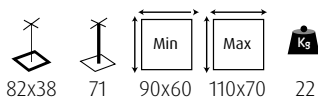

Retro Large



S15

Noir
Black

Fonte d'acier - Epoxy noir - Vérins de réglage.
Cast iron - Powder coated in black - Adjustable footplugs.



Bistrot

Pied de table - *Table base*



Bistrot 3 H43



Bistrot 3

Noir
Black



S15

Fonte d'acier* - Epoxy noir - Vérins de réglage.
Cast iron* - Powder coated in black - Adjustable footplugs.



⚠ *Ces articles peuvent rouiller en utilisation extérieure.
*These items may rust when used outdoor.

Bistrot 3 H43

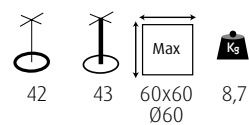

Bistrot 3

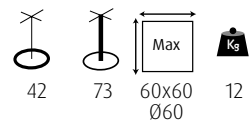

Bistrot

Pied de table - *Table base*



Bistrot 4



Bistrot 3 Bar



S15

Noir
Black

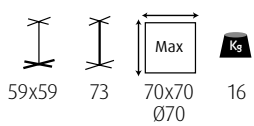

Bistrot 4

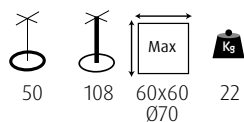

Bistrot 3 Bar

Fonte d'acier* - Epoxy noir - Vérins de réglage.
Cast iron - Powder coated in black - Adjustable footplugs.*



*Ces articles peuvent rouiller en utilisation extérieure. ⚠️
**These items may rust when used outdoor.*

Prato

Pied de table - *Table base*



Prato 16



Prato 19



Prato 30

Noir Mat
Matt Black



S14

Fonte d'acier - Epoxy noir mat - Vérins de réglage.
Cast iron - Powder coated in black - Adjustable footplugs.



Prato 16

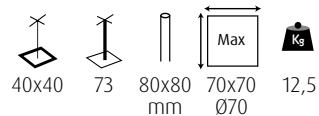

Prato 19

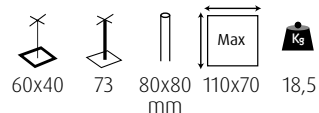

Prato 30

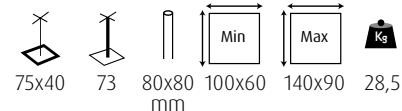

Prato

Pied de table - *Table base*



Prato 16 Bar



Prato 30 Bar

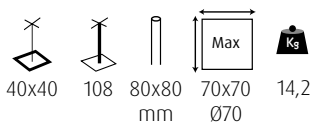

Prato 16 Bar



S14

Noir Mat
Matt Black

Fonte d'acier - Epoxy noir mat - Vérins de réglage.
Cast iron - Powder coated in black - Adjustable footplugs.

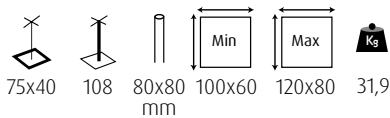

Prato 30 Bar



Prato

Pied de table - Table base



Prato 15



Prato 15 Bar

Noir Mat
Matt Black



S14

Fonte d'acier - Epoxy noir mat - Vérins de réglage.
Cast iron - Powder coated in black - Adjustable footplugs.



Prato 15

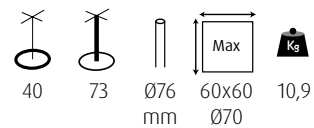

Prato 15 Bar

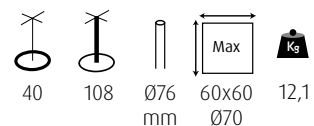

Prato

Pied de table - Table base



Prato 20



Prato 70



S14

Noir Mat
Matt Black

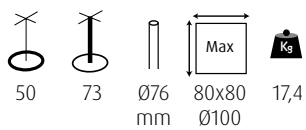

Prato 20

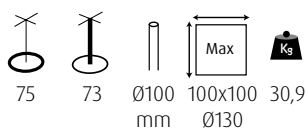

Prato 70

Fonte d'acier - Epoxy noir mat - Vérins de réglage.
Cast iron - Powder coated in black - Adjustable footplugs.



Rome

Pied de table - *Table base*



Rome 05



Rome 06



Rome 05 Bar

Noir
Black



S15

Fonte d'acier - Epoxy noir - Vérins de réglage.
Cast iron - Powder coated in black - Adjustable footplugs.



Rome 05					
	43	73	Ø76 mm	60x60 Ø80	14
Rome 06					
	55	73	Ø76 mm	90x90 Ø120	21
Rome 05 Bar					
	43	108	Ø76 mm	60x60 Ø70	15

Rome

Pied de table - *Table base*



Rome 12



Rome 13



Rome 12 Bar

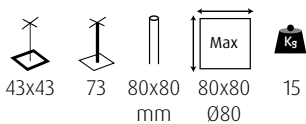

Rome 12



S15

Noir
Black

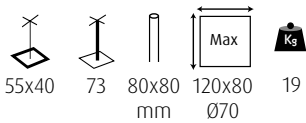

Rome 13

Fonte d'acier - Epoxy noir - Vérins de réglage.
Cast iron - Powder coated in black - Adjustable footplugs.

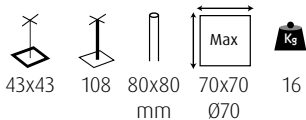

Rome 12 Bar



Stratifié - Laminate

New

Original Collection

Plateau de table - Table top



Noyer
0H251 W06

New



Marbre Samas
3482

New



Marmara
F 160 ST9



Marbre Blanc
0F253 BST

cm	□			▭				○	
	60x60	70x70	80x80	60x70	110x70	120x70	120x80	Ø70	Ø120 *
24mm	6,8kg	8,1kg	10,9kg	7,5kg	12,9kg	14kg	16,2kg	6,4kg	21,3kg

* 26 mm



i p305

Plateau stratifié - Chants en ABS - Disponible en épaisseur 24mm uniquement*.
Laminate table top - ABS edges - Available only in thickness of 24mm*.





Stratifié-Laminate

Original Collection



Stratifié - Laminate

Perfect Sense Collection

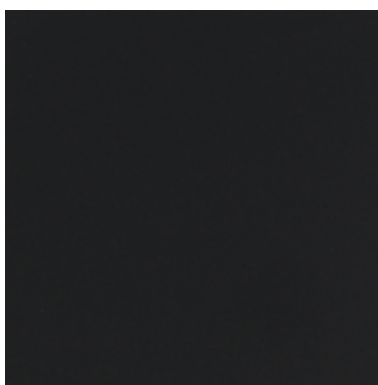
Plateau de table - *Table top*



Noir - *Black*
PT U999

		
cm	60x60 70x70	120x70
20mm	4,8kg 6,5kg	11,2kg



 p305

Plateau stratifié - Chants en ABS - Extra mat - Toucher soyeux - Anti-traces de doigts - Anti-reflets - Disponible en épaisseur 20mm uniquement*.

Laminate table top - ABS edges - Extra matte - Silky touch - Fingerprint proof - Anti-reflective - Available only in thickness of 20mm.*





Stratifié-Laminate

Perfect Sense Collection

Stratifié - Laminate

Chêne - Oak Halifax

Plateau de table - Table top



Chêne Halifax Naturel
H 1180 ST37

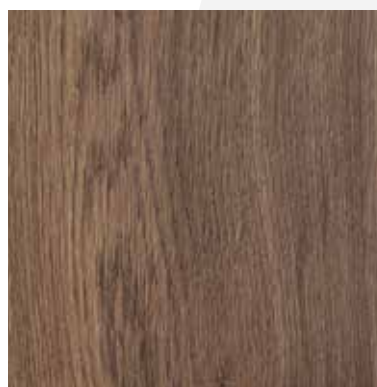

Chêne Halifax Tabac
H1181 ST37

cm	□			▭				○	
	60x60	70x70	80x80	60x70	110x70	120x70	120x80	Ø70*	Ø120*
24mm	5,9kg	8,3kg	10,4kg	7,2kg	12,7kg	13,7kg	16,1kg	6,5kg	19,7kg 26 mm
46mm	8,5kg	10,7kg	13,5kg	9,4kg	15,7kg	17,1kg	19,2kg	/	/

* Uniquement: Naturel H 1180 ST37

* Only: Naturel H 1180 ST37



i p305

Plateau stratifié aspect bois - Chants en ABS imitation « Bois de bout » - Toucher « Feelwood » : suit les fibres du bois.

Laminate table top with wood-like appearance - ABS edges - « Feelwood » touch : realistic look and feel of the wooden fibers.





Stratifié-Laminate

Chêne - Oak Halifax

Méla miné

Melamine



Plateau de table - Table top



Minnesota Oak Chocolat
H441 Z5L



Chêne Halifax Naturel
H 1180 ST37

			
cm	60x60	70x70	120x70
18mm	4,4kg	6,2kg	11,2kg



 p305

Plateau mélaminé aspect bois - Chants en ABS imitation « Bois de bout »
Toucher « Feelwood » - Epaisseur 18mm.

Melamine table top with wood-like appearance - ABS edges - « Feelwood »
touch - Thickness 18mm.

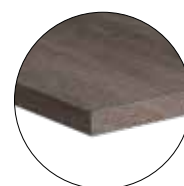



Mélaminé

Melamine



Odense

Chêne-Oak

Plateau de table - *Table top*



Finition rustique naturelle brossée
Natural rustic brushed finish

			
cm	60x60	70x70	120x70
30mm	8,4kg	11,1kg	19kg

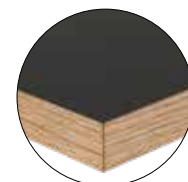

 p305

Plateau bois plaqué chêne - Finition rustique naturelle brossée - 4 couches de vernis polyuréthane satiné - Epaisseur 30mm.

Wooden oak veneered top - Natural rustic brushed finish - 4 coats of polyurethane satin lacquer - Thickness 30mm.

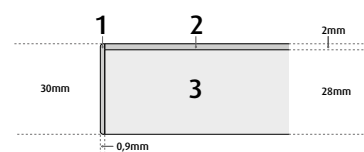

- 1. Chants plaqués
 - 2. Plaquage Chêne
 - 3. Aggloméré
- 1. *Veneer edges*
 - 2. *Oak veneer*
 - 3. *Chipboard*



Odense

Chêne-Oak

William

Buffet - Buffet



Wengé
Wenge

Bardolino
Bardolino



Structure en mélamine - Tablettes en stratifié - 4 roulettes dont 2 avec frein - Porte à droite - Meuble monté - Usage intérieur uniquement.
Melamine structure - Laminated shelves - 4 casters, including 2 with brakes - Door on the right side - Assembled - Indoor use only.

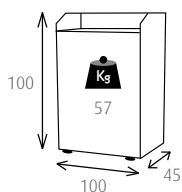



William

Jacky

Meuble poubelle - Waste bin



Wengé
Wenge



Bardolino
Bardolino



ACCESSOIRE

Poubelle PVC 80L
PVC trashbin 80L



80 L



Structure en mélamine - Tablette en stratifié - Battant en inox lesté - 4 roulettes dont 2 avec frein - Fermeture à clé - Meuble monté - Usage intérieur uniquement.

Melamine structure - Laminated shelf - Weighted stainless steel flap - 4 casters, including 2 with brakes - Key lock - Assembled - Indoor use only.

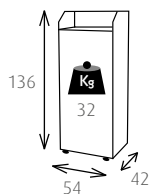



Jacky





Réception - Catering

Tiffany

Stock
Limité
Limited
Stock

Chaise - Chair



Noir Brillant
Glossy Black

Monobloc polypropylène.
Polypropylene monobloc.

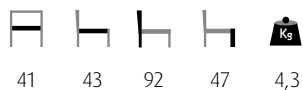



Tiffany

XL 180

Table - Table

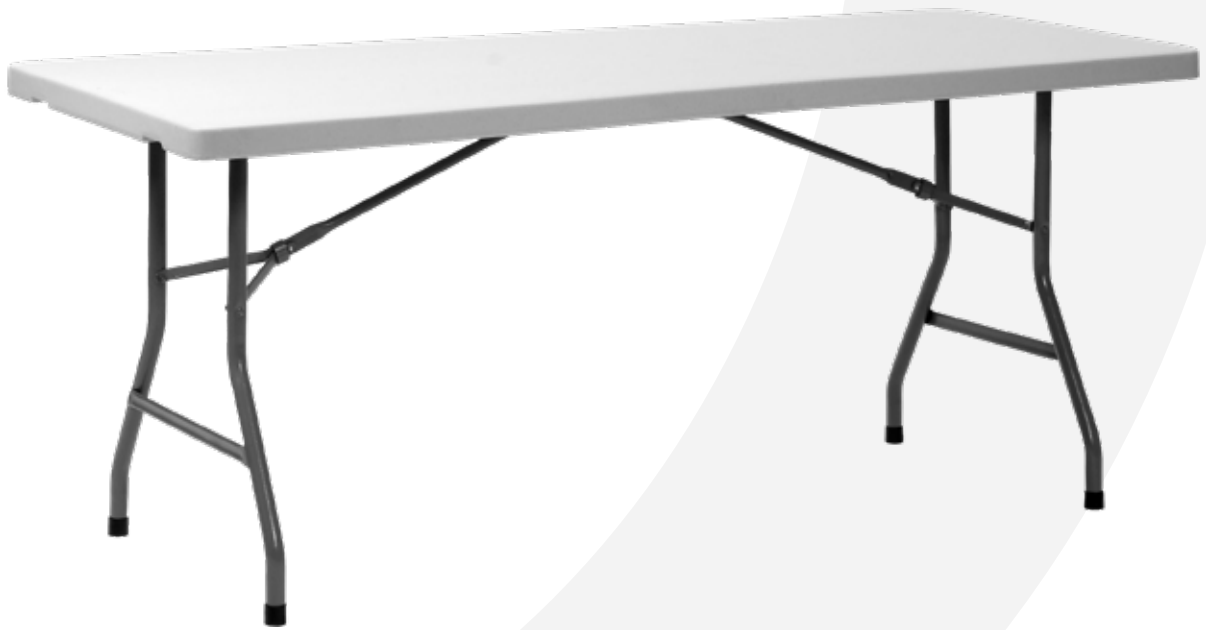

Blanc
White



Piètement métallique pliant - Diamètre tube 28mm - Plateau polyéthylène épaisseur 45mm.
Folding metal table base - Tube diameter 28mm - Polyethylene table top thickness 45mm.



182x75 74 14



Cocktail 80

Table haute - *High table*

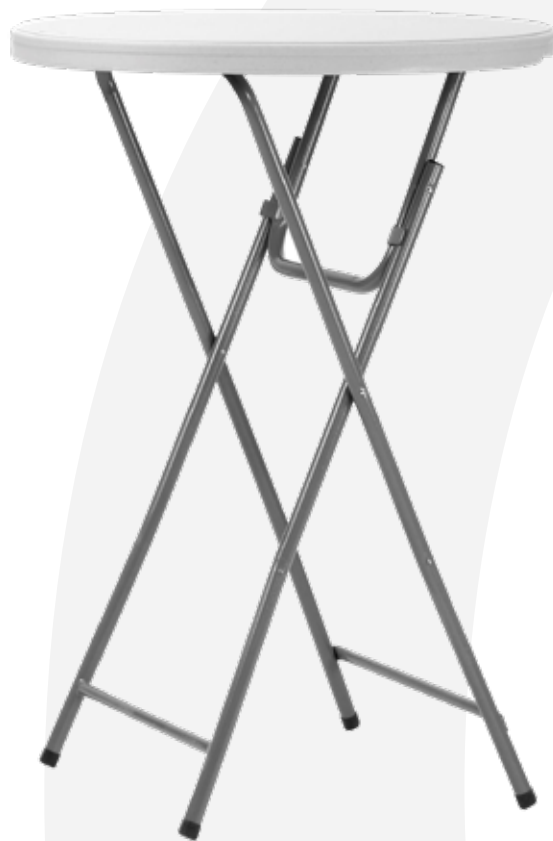

Blanc
White



Piètement métallique pliant - Diamètre tube 22mm - Plateau polyéthylène épaisseur 45mm.
Folding metal table base - Tube diameter 22mm - Polyethylene table top thickness 45mm.



81 110 8

Osaka

Nappe - Cover



Noir
Black



Comprend : 1 nappe + 1 surnappe - Finition stretch 100% polyester - Renforts sur les pieds.
Consists of 1 table cover + 1 topper - 100% stretch polyester - Foot reinforcements.



Pack Cocktail 80 & Osaka

Ensemble - Set



Noir
Black



Ensemble composé de : **1** table Cocktail 80 + **1** nappe + **1** surnappe Osaka - Noir.
Set composed of : **1** Cocktail 80 table + **1** Osaka cover + **1** topper - Black.







Divers - Miscellaneous Info

Informations techniques

Technical information

Textilène - *Textilene*

Fibre de polyester enduite de PVC - *Coated polyester fiber.*

Revêtement textilène - *Textilene covering*



R31
Odéon/Bercy
Crème & Vert
Cream & Green 8x8



R32
Odéon/Bercy
Blanc & Camel
White & Camel 8x8



R28
Limoges
Gris & Blanc
Grey & White 8x8

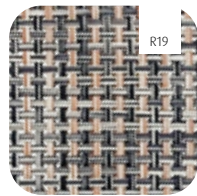

R19
Reims/Blois/Dole
Gris & Beige
Grey & Beige 4x4

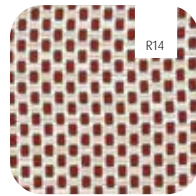

R14
Paris
Bordeaux & Crème
Bordeaux & Cream 8x8

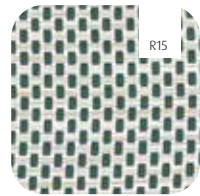

R15
Paris
Vert & Crème
Green & Cream 8x8



R33
Paris
Noir & Blanc
Black & White 8x8

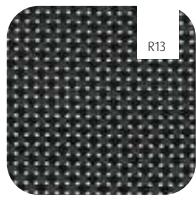

R13
Paris/Montmartre
Noir
Black 8x8



R11
Drouot/Trocadero
Noir & Gris Clair
Black & Light Grey 8x8

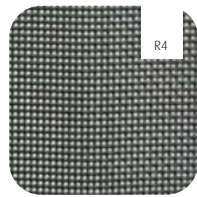

R4
Dauphine
Noir
Black 2x2

Corde textilène - *Textilene rope*



R25
Murcia
Terracotta
Terracotta



R24
Murcia
Noir
Black



R23
Murcia
Taupe
Taupe



R18
Cadix
Anthracite
Anthracite



R18
Concorde
Anthracite
Anthracite

*Non disponible dans la boîte échantillons
*Not available in the sample box

Bamboo Look - *Bamboo look*



S4
Metz, Dax, Orléans,
Rochelle, Brest, Laval
Bamboo Look Caramel
Caramel Bamboo Look



S5
Limoges, Vilette,
Madeleine
Bamboo Look Clair
Light Bamboo Look



S6
Paris, Montmartre
Bamboo Look Foncé
Dark Bamboo Look

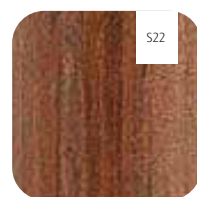

S22
Reims, Blois, Dole
Bamboo Look Chestnut
Chestnut Bamboo Look



S27
Dax
Bamboo Look Foncé
Dark Bamboo Look



S31
Odeon, Bercy
Bamboo Look Clair
Light Bamboo Look



S32
Paris
Bamboo Look Clair
Light Bamboo Look

Métal - *Metal*



S34
Bastille/Bastille Bst/
Pigalle
Saugé
Saugé



S33
Bastille/Bastille Bst/
Pigalle
Terra
Terra



S7
Bastille/Bastille Bst/
Pigalle
Anthracite
Anthracite



Informations techniques

Technical information

Tressage PE - PE Wicker



R34
Loom/Loyd
Rotin Naturel
Natural Rattan



R16
Metz/Brest/Laval
Rotin Noisette
Nut Rattan

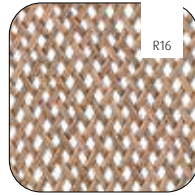

R16
Rochelle/Dax
Rotin Noisette
Nut Rattan

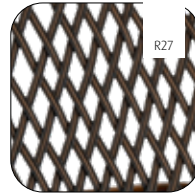

R27
Dax
Rotin Marron foncé
Dark Brown Rattan

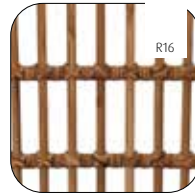

R16
Orléans
Rotin Noisette
Nut Rattan

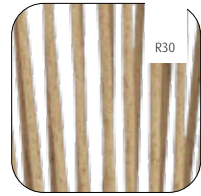

R30
Denia/Alicante
Sable
Sand 5mm



R29
Denia/Alicante
Terra
Terra 5mm



R30
Denia/Alicante
Sable
Sand 10x5mm



R29
Denia/Alicante
Terra
Terra 10x5mm



S1 R1
Savana/Javea
Paille
Straw Ø5mm



S1 R2
Savana
Olive
Olive Ø5mm



S1 R2
Amsterdam/Breda
Olive
Olive Ø5mm



S1 R1
Amsterdam/Breda
Paille
Straw Ø5mm



S1 R3
Amsterdam/Breda
Anthracite
Anthracite Ø5mm



R26
Saint-Raphaël
Anthracite
Anthracite

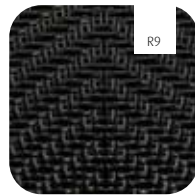

R9
Villette/Madeleine
Noir
Black

Polypropylène - Polypropylene



Monna/Maya/Atlantic/Penelope/
Ulysse/Achille Bar 75/Tom Bar 75/Sky
Pro/Marcel/Marcel XL/Marcel Bst/Kys
Noir Mat
Matte Black



Monna/Maya/Maya Bar
75/Tom Bar/Sky Pro
Olive
Olive



Monna
Moutarde
Moutarde



Monna
Octane
Octane



Penelope/Ulysse/
Achille Bar 75/Tom Bar 75
Marsala
Marsala



Maya/Maya Bar 75
Blanc
White

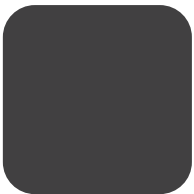

Maya/Maya Bar 75
Gris foncé
Dark Grey

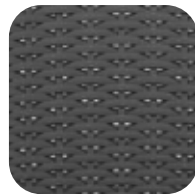

Daytona/Panama/Jamaica
Jamaica F/Jamaica Bst
Gris Foncé
Dark Grey



Doha/Cairo/Dubai
Jeddah/Oman
Anthracite
Anthracite



Doha/Cairo/Dubai
Jeddah/Oman
Taupe
Taupe



Doha/Cairo/Dubai
Jeddah/Oman
Saugé
Sage



Doha/Cairo/Dubai
Jeddah/Oman
Terra
Terra

*Non disponible dans la boîte échantillons
*Not available in the sample box



Doha/Cairo/Dubai/Jeddah/Oman :
CEN/TR 581-4:2005 ; ISO 4892-2:2013/Amd. 1:2021 Cycle 1 ; ISO 4628-2:2016 ; ISO 4628-4:2016 ; ISO 4628-5:2016 ; ISO 4628-6:2011
Résistance aux UV - UV Resistant

Informations techniques

Technical information

Compact Easy - *Compact Easy* 

Chants droits - Système de fixation universel.
Straight edges - Universal fixing system.



Colorado
459



Corten
406



Grafito
918



Marmo Bianco
654

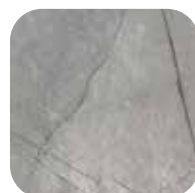

Marmo Griggio
671



Slate
658

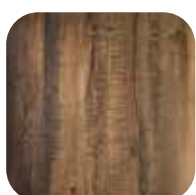

Alaska Oak
694



Black Meteor
11



Padova
804



Terrazzo
669

Stratifié Moulé Classique - *Molded Laminated Classic* 

Plateau stratifié moulé.
Molded laminated top.



Avalon Pine
4729



Irony
9687

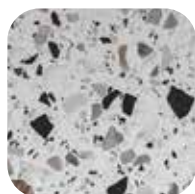

Malaga
5766



Basalt
5810



Hausmann
4723



Granit Light
5807

Stratifié Moulé Cerclé - *Molded Laminated Rimmed* 

Plateau stratifié moulé
Cerclage métallique finition laiton.
Rimmed table top - Brass finish metal band.

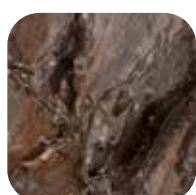

Marrakesh
5717

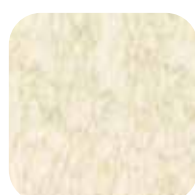

Mermer
5410



Black Siyah
3190

Informations techniques

Technical information

Tables Basses - Low Tables

Plateau mélaminé.
Melamine table top.



Maryne
Marbre noir
Black marble



Jolyne
Mango
Mango



Jolyne
Noir
Black



Ellen
Naturel
Natural

Stratifié Perfect Sense Collection - Laminate Perfect Sense Collection



Plateau stratifié - Chants en ABS - Extra mat - Touché soyeux -
Anti-traces de doigts - Anti-reflets.

Laminate table top - ABS edges - Extra matte - Silky touch -
Fingerprint proof - Anti-reflective.

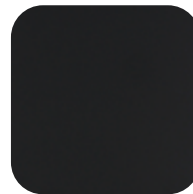

Noir - Black
PT U999

Stratifié Original Collection - Laminare Original collection



Plateau stratifié - Chants en ABS (Acrylonitrile Butadiène Styrene).
Molded laminated top - ABS (Acrylonitrile Butadiene Styrene) edges.



Marbre Blanc
OF253 BST

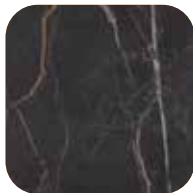

Marbre Samas
3482



Marmara
F 160 ST9

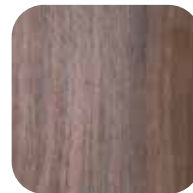

Noyer
OH251 W06

Stratifié Chêne - Laminare Oak Halifax



Plateau stratifié aspect bois touché «feelwood» - Chants en ABS (Acrylonitrile Butadiène Styrene) imitation bois de bout.
«Feelwood» wood-look laminated top - ABS (Acrylonitrile Butadiene Styrene) edges.

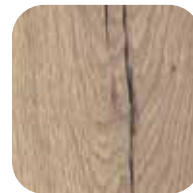

Chêne Halifax Naturel
H1180 ST37

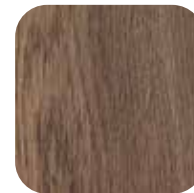

Chêne Halifax Tabac
H1181 ST37

Mélaminé - Melamine



Plateau mélaminé aspect bois touché «feelwood» - Chants en ABS (Acrylonitrile Butadiène Styrene) imitation bois de bout.
«Feelwood» wood-look melamine top - ABS (Acrylonitrile Butadiene Styrene) edges.



Chêne Halifax Naturel
H1180 ST37



Minnesota Oak Chocolat
H441 Z5L

Odense



Bois plaqué chêne - 4 couches de vernis polyuréthane satiné.
Oak veneered wood - 4 coats of polyurethane satin lacquer.



Finition rustique naturelle brossée
Natural rustic brushed finish

Informations techniques

Technical information

Revêtements - Upholstery

Entretien

Le nettoyage et l'entretien réguliers des tissus d'ameublement prolongent leur durée de vie et empêchent la formation de salissures permanentes. Une solution d'eau et de savon doux peut être utilisée pour nettoyer le tissu.

Conservation

Le boulochage des tissus est un processus naturel et peut ne pas être complètement éliminé. L'exposition à la lumière UV et aux sources de chaleur peut provoquer une décoloration du tissu (ceci concerne principalement les couleurs intenses). Pour des raisons technologiques, la teinte d'un tissu peut différer d'un ton par rapport à l'échantillon présenté dans le catalogue. Les photos sont non contractuelles. Les tissus sont conformes aux exigences du règlement européen sur les produits chimiques dangereux (REACH) n° 1907/2006, annexe XVII.

Nettoyage

Étape 1: Enlevez soigneusement l'excès de saleté.

Étape 2: Imbibez la tache d'eau froide et épongez-la avec une serviette en papier.

Étape 3: Laissez sécher.

Maintenance

Regular cleaning and maintenance of upholstery fabrics prolongs their life and prevents the formation of permanent soiling. A mild soap and water solution can be used to clean the fabric.

Preservation

Pilling of fabrics is a natural process and may not be completely eliminated. Exposure to UV light and heat sources can cause discoloration of the fabric (this applies mainly to dark colours). For technological reasons, the shade of a fabric may differ by one shade from the sample shown in the catalog. Photos are non-contractual. Fabrics comply with the requirements of the European regulation on hazardous chemicals (REACH) n° 1907/2006, annex XVII.

Cleaning

Step 1: Carefully remove excess dirt.

Step 2: Soak the stain in cold water and blot with a paper towel.

Step 3: Allow to dry.

Wind • Eloise, Romeo, Tristan Bst, Clothilde



Greige 05
Greige 05



Terra 56
Terra 56



Vert 75
Green 75

Composition

100% Polyester

Poids - Weight

230 g/m² (+/-5%)

Test Martindale

30.000-40.000 tours min.

Largeur rouleau

Usable width of roll

140 cm.



BS 5852
EN 1021/1



DAVIS
FABRICS

www.davis.pl/kolekcja/wind

Sorella • Ginette, Angèle, Marius Bst, Eugénie



Greige 05
Greige 05



Gris Foncé 88
Dark Grey 88

Composition

100% Polyester

Poids - Weight

350 g/m²

Test Martindale

60.000/70.000 tours min

Largeur rouleau

Usable width of roll

140 cm.



BS 5852
EN 1021/1



DAVIS
FABRICS

www.davis.pl/kolekcja/sorella

Aragon • Simone, René, Auguste



Vert 39
Green 39



Terra 59
Terra 59

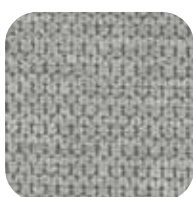

Gris Clair 83
Light Grey 83

Composition

5% NY
95% PES

Poids - *Weight*
340 g/m² (+/-5%)

Test Martindale
45.000-60.000 tours min.

Largeur rouleau
Usable width of roll
140 cm.

www.davis.pl/kolekcja/aragon



Gava • Mélina, Sandra



Gris 18
Grey 18

Composition

100% Recycled PES

Poids - *Weight*
450 g/m²

Test Martindale
>100.000 tours min

Largeur rouleau
Usable width of roll
140 cm.

www.davis.pl/kolekcja/gava



Luis • Kate



Vert 34
Green 34



Bleu 75
Blue 75



Gris 90
Grey 90



Rouille 52
Rusty 52

Composition

100% PES

Poids - *Weight*
350 g/m²

Test Martindale
20.000-30.000 tours min.

Largeur rouleau - *Usable width of roll*
140 cm.

www.davis.pl/kolekcja/luis



Monolith • Emile, Alfonse, Oscar Bst, Lautrec S, Arnold, Willy



Anthracite 92
Anthracite 92



Burgundy 69
Burgundy 69



Gold 48
Gold 48



Petrol 76
Petrol 76



Olive 38
Olive 38

Composition

100% PES

Poids - *Weight*
330g/m³ (+/-5%)

Test Martindale
>100.000 tours min.

Largeur rouleau
Usable width of roll
140 cm.

www.davis.pl/kolekcja/monolith



Informations techniques

Technical information

Revêtements - *Upholstery*

Miss • Zoé, Ralph



Beige 032
Beige 032



Gris/Brun 056
Brown/Grey 056



Olive 144
Olive 144



Orange 106
Orange 106

Composition
96% PES 4%NY

Poids - *Weight*
410g/m²

Test Martindale
40.000 tours min.

Largeur rouleau
Usable width of roll
142 cm.



Brego • Noélia

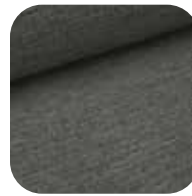

Gris 10
Grey 10

Composition
100% PES

Poids - *Weight*
380g/m²

Test Martindale
30.000 tours min

Largeur rouleau
Usable width of roll
140 cm.



www.fabb.pl/brego-collection

Colorado • Mikka, Olaf, Jacob, Kyle, Wendy



Cuoio
Cuoio



Anthracite
Anthracite

Composition
100% PU
81% PES + 15% Cotton
+ 4% Viscose

Poids - *Weight*
630g/m² (+/-5%)

Test Martindale
>250.000 tours min.

Largeur rouleau
Usable width of roll
140 cm.



BS 5852/0
EN 1021/1



www.elastrongroup.com/en/upholstery/fabrics/colorado

Cortes • Cuba, Cuba Double



Brun Clair 41
Light Brown 41

Composition
100% PES

Poids - *Weight*
330g/m²

Test Martindale
35.000 tours min.



www.fabb.pl/cortes-collection

Lotos • Budapest, Budapest Bst, Dimitri, Dimitri Bst, Brooklyn, Brooklyn Bst, Pub, Pub Bst, Clinton, Clinton Bst



Olive 943
Olive 9430



Terra 9244
Terra 9244



Noir 7006
Black 7006



Éléphant 5272
Elephant 5272



Cappuccino 5582
Cappuccino 5582



Bordeaux 5269
Bordeaux 5269

Composition
100% PU

Poids - *Weight*
392g/m² (+/-5%)

Test Martindale
>100.000 tours min.

Largeur rouleau
Usable width of roll
140 cm.



www.textum-stoffe.com/products-detail.html?fabric_name=Lotos

PU • Floriane II, Floriane Bst II



Chocolat 928
Chocolate 928



Noir 9100
Black 9100



Taupe 926
Taupe 926

Composition
66% PU
30% PES
1,3% CV
2,7% COT

Poids - *Weight*
340g/m² (+/-5%)

Test Martindale
100.000 tours min.

Largeur rouleau
Usable width of roll
144 cm.



Softyl • Condor



Anthracite
Anthracite



Cognac
Cognac

Composition
100% PES

Poids - *Weight*
360g/m²

Test Martindale
45.000 tours min.

Informations techniques

Technical information

Non-feu

PVC Classement Non-feu - Normes EN 1021 partie 1 (EN 1021/1) ou EN 1021 partie 2 (EN 1021/2)
PVC fire resistant rating - Standards EN 1021 part 1 (EN 1021/1) or EN 1021 part 2 (EN 1021/2)



Méthode de test:

Un banc d'essai est construit à l'aide de mousse et de tissu pour simuler une chaise.

1. Méthode de test - Partie 1: Une cigarette est allumée et placée dans la crevasse du banc de test en contact avec le dossier et le siège. Elle se consume sur toute sa longueur. Le tissu est observé par rapport à la couvaison ou l'inflammation.

2. Méthode de test - Partie 2: Le banc de test composé est à présent testé avec une flamme au butane, qui simule une allumette allumée, dans la crevasse. Après avoir retiré la flamme, le tissu est observé pour voir s'il couve ou s'enflamme dans les 2 min.

3. Résultat: Le matériau de test réussit le test s'il n'y a pas eu d'inflammation ou en cas de zone de combustion limitée.

Test method:

A test rig is constructed using foam and fabric in order to simulate a chair.

1. Test method - Part 1: A cigarette is lit and placed in the crevice of the test rig which is in contact with the backrest and the seat. The cigarette is left to smoulder while the reaction of the tissue is being observed during the process of combustion and inflammation.

2. Test method - Part 2: The test rig is now tested with a butane flame, which simulates a burning match, placed into the crevice. After removing the flame, the reaction of the tissue is being observed to see if it smoulders or ignites within 2 minutes.

3. Result: The test material passes the test if there is no evidence of ignition or if the smouldering site is within the limited acceptable size.

PVC Classement Non-feu - Norme BS 5852 source 0

PVC fire resistant rating - Standard BS 5852 source 0

Méthode de test:

Un banc d'essai est construit pour simuler une chaise avec le tissu à tester. Ce banc est soumis à différentes sources d'allumage. Il y a 8 types de sources d'allumage, chacune avec une intensité de chaleur différente. Elles sont classées de 1 à 8, avec une intensité qui double par rapport à la source précédente.

1. Méthode de test - Source 0: Cigarette qui se consume. Une cigarette est placée le long de la crevasse du banc de test et peut brûler sur toute sa longueur.

Si aucune inflammation ou couvaison progressive n'est observée sur la couverture et le matériau intérieur, le test est enregistré comme étant sans allumage et le matériau réussit le test.

2. Résultat: Le matériau de test réussit le test s'il n'y a pas eu d'inflammation ou en cas de zone de combustion limitée.

Test method:

A test rig is constructed in order to simulate a chair with the fabric to be tested. This rig is subjected to different ignition sources. There are 8 types of ignition sources, each with different heat intensity. They are classified from 1 to 8, the intensity doubling the precedent source.

1. Test method Source 0: A smouldering cigarette. It is lit and placed in the crevice of the test rig and is left to smoulder. If no combustion or inflammation is observed on the cover and the inner material, the test is recorded as no ignition and the material passes the test.

2. Result: The test material passes the test if there is no evidence of ignition or if smouldering site is within the limited acceptable size.

Informations techniques

Technical information

Stratifié/Méla miné - *Laminate/Melamine*



Méla miné
Melamine



Stratifié
Laminate

Comparatif *Comparison*

Résistance à la chaleur:

Le stratifié est plus résistant à la chaleur et sera donc conseillé dans le cas d'une utilisation avec service de plats chauds à table.

Réaction au feu:

Méla miné: M3 Stratifié: M2

Résistance à l'usure:

Le stratifié comprend une couche de protection, pas le méla miné.

Résistance aux coups/chocs:

Le stratifié comprend une couche support en résine, pas le méla miné ; le méla miné est appliqué directement sur le panneau aggloméré.

Prix:

Le stratifié est sensiblement plus cher que le méla miné.

Heat resistance:

Laminate is more resistant to heat and is therefore advised for use with hot plates.

Reaction to fire:

Melamine: M3 Laminate: M2

Wear resistance:

Laminate has a protective coating and melamine does not.

Stock/Impact resistance:

Laminate has an additional layer of resin while the melamine is directly applied to the chipboard.

Price:

Laminate is significantly more expensive than melamine.

Composition *Composition*

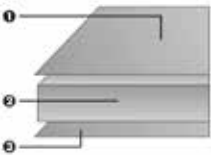

Méla miné
Melamine

Un film de méla miné est appliqué sur le panneau aggloméré à pression et température élevées. Ce film comprend un papier de base trempé dans de la résine de méla miné. Il peut être imprimé ou non et son poids peut varier. Un papier plus lourd peut absorber plus de résine, de sorte que la couche de méla miné est aussi plus épaisse.

1. Feuille de papier décoratif, imprégnée de résine de méla miné.
2. Panneau aggloméré.
3. Feuille de papier décoratif, imprégnée de résine de méla miné.

A melamine film is pressed onto the chipboard at high pressure and temperature. This film consists of a paper substrate saturated with melamine resin. This paper may or may not be printed and its weight may vary. A heavier paper can absorb more resin, resulting in a thicker melamine layer.

1. Sheet of decorative paper saturated with melamine resin.
2. Chipboard.
3. Sheet of decorative paper saturated with melamine resin.

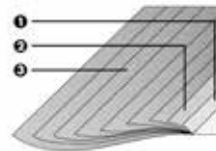

Stratifié
Laminate

Le stratifié à haute pression est constitué d'un empilement de feuilles de papier imprégnées de résines thermodurcissables, qui sont polymérisées sous l'effet d'une pression (8 MPa) et d'une température élevée (150°C).

1. Couche de protection (overlay) imprégnée de résine méla miné (pour tous les décors).
2. Papier décoratif : teinté dans la masse pour les teintes unies ou imprimé pour les décors, imprégné de résine de méla miné.
3. Coeur: un certain nombre de feuilles de papier kraft, imprégnées de résine de phénol.

High-pressure laminate consists of a stack of sheets of paper saturated with thermosetting resin which are polymerized under high pressure (8 MPa) and temperature (150°C).

1. Melamine resin-saturated overlay (for all decors).
2. Decorative paper: mass-dyed for solid colors or printed for decors, saturated with melamine resin.
3. Core: a number of sheets of kraft paper, saturated with phenol resin.

Correspondance Pieds/Plateaux

Matching table tops and bases

Piètements Extérieurs Outdoor Table Bases		Modena 3	Modena 4	Modena Double	Modena 4 Bar	Kyoto 4	Kyoto 4 Bar	Monza	Monza Bar	Berlin 4	Berlin 2	Berlin 4 Bar
Compact Easy 12mm	65x65	-	✓☁	-	✓☁	✓☁	✓☁	✓☁	-	✓☁	-	✓☁
Stratifié Moulé Classic 32mm Basalt Haussmann Granit Light	60x60	-	✓☁	-	✓☁	✓☁	✓☁	✓☁	✓☁	✓☁	-	✓☁
	70x70	-	✓☁	-	✓☁	✓☁	✓☁	✓☁	-	✓☁	-	✓☁
	Ø60	✓☁	-	-	-	-	-	-	✓☁	-	-	-
Stratifié Moulé Cerclés Rimmed Molded Laminate 30mm Marrakesh Mermer Black Siyah	Ø60	✓☁	-	-	-	-	-	-	✓☁	-	-	-
Stratifié Perfect Sense Collection Perfect Sense Laminate 20mm Noir - Black	60x60	-	✓	-	✓	✓	✓	✓	✓	✓	-	✓
	70x70	-	✓	-	✓	✓	✓	✓	-	✓	-	✓
	120x70	-	-	✓	-	-	-	-	-	-	✓	-
Stratifié Original Collection Original Collection Laminate 24mm Noyer - Walnut Marbre Samas - Samas Marble Marmara Marbre Blanc - White Marble	60x60	-	✓	-	✓	✓	✓	✓	✓	✓	-	✓
	70x70	-	✓	-	✓	✓	✓	✓	-	✓	-	✓
	80x80	-	-	-	-	✓	-	-	-	✓	-	-
	60x70	-	✓	-	✓	✓	✓	✓	-	✓	-	✓
	110x70	-	-	✓	-	-	-	-	-	-	✓	-
	120x70	-	-	✓	-	-	-	-	-	-	✓	-
Stratifié Chêne Halifax Oak Halifax Laminate 24mm & 46mm Chêne Halifax Naturel Chêne Halifax Tabac	120x80	-	-	✓	-	-	-	-	-	-	✓	-
	Ø70	-	✓	-	✓	✓	✓	✓	✓	✓	-	✓
	Ø120	-	-	-	-	-	-	-	-	-	-	-
Mélaminé Melamine 18mm Minnesota Oak Chocolat Chêne Halifax Naturel	60x60	-	✓	-	✓	✓	✓	✓	✓	✓	-	✓
	70x70	-	✓	-	✓	✓	✓	✓	-	✓	-	✓
	120x70	-	-	✓	-	-	-	-	-	-	✓	-
Chêne Odense Oak Odense 30mm	60x60	-	✓	-	✓	✓	✓	✓	✓	✓	-	✓
	70x70	-	✓	-	✓	✓	✓	✓	-	✓	-	✓
	120x70	-	-	✓	-	-	-	-	-	-	✓	-

Correspondance Pieds/Plateaux

Matching table tops and bases

Piètements Extérieurs Outdoor Table Bases		Empire 3	Empire 4	Empire 4 Bar	Empire 2	Empire Grande	Bistrot 3 H43	Bistrot 3	Bistrot 4	Bistrot 3 Bar
Compact Easy 12mm	65x65	-	✓☁	-	-	-	-	-	✓☁	-
Stratifié Moulé Classic 32mm Basalt Haussmann Granit Light	60x60	✓☁	✓☁	✓☁	-	-	✓☁	✓☁	✓☁	✓☁
	70x70	-	✓☁	-	-	-	-	-	✓☁	-
	Ø60	✓☁	✓☁	✓☁	-	-	✓☁	✓☁	✓☁	✓☁
Stratifié Moulé Cerclés Rimmed Molded Laminate 30mm Marrakesh Mermer Black Siyah	Ø60	✓☁	✓☁	✓☁	-	-	✓☁	✓☁	✓☁	✓☁
Stratifié Perfect Sense Collection Perfect Sense Laminate 20mm Noir - Black	60x60	✓	✓	✓	-	-	✓	✓	✓	✓
	70x70	-	✓	-	-	-	-	-	✓	-
	120x70	-	-	-	✓	-	-	-	-	-
Stratifié Original Collection Original Collection Laminate 24mm Noyer - Walnut Marbre Samas - Samas Marble Marmara Marbre Blanc - White Marble	60x60	✓	✓	✓	-	-	✓	✓	✓	✓
	70x70	-	✓	-	-	-	-	-	✓	-
	80x80	-	-	-	-	✓	-	-	-	-
	60x70	-	✓	-	-	-	-	-	✓	-
	110x70	-	-	-	✓	-	-	-	-	-
Stratifié Chêne Halifax Oak Halifax Laminate 24mm & 46mm Chêne Halifax Naturel Chêne Halifax Tabac	120x70	-	-	-	✓	-	-	-	-	-
	120x80	-	-	-	✓	-	-	-	-	-
	Ø70	✓	✓	✓	-	-	-	-	✓	✓
Mélaminé Melamine 18mm Minnesota Oak Chocolat Chêne Halifax Naturel	Ø120	-	-	-	-	✓	-	-	-	-
	60x60	✓	✓	✓	-	-	✓	✓	✓	✓
	70x70	-	✓	-	-	-	-	-	✓	-
Chêne Odense Oak Odense 30mm	120x70	-	-	-	✓	-	-	-	-	-
	60x60	✓	✓	✓	-	-	✓	✓	✓	✓
	70x70	-	✓	-	-	-	-	-	✓	-

Correspondance Pieds/Plateaux

Matching table tops and bases

Piètements Intérieurs Indoor Tables Bases		Gallia 4	Gallia 4 Bar	Gallia 4 XL	Gallia Double	Factory 70	Retro Small	Retro Large	Prato 16	Prato 19	Prato 30	Prato 16 Bar	Prato 30 Bar	
Compact Easy 12mm	65x65	✓	✓	-	-	-	-	-	✓	-	-	✓	-	
Stratifié Moulé Classic 32mm Basalt Hausmann Granit Light Avalon Pine Irony Malaga	60x60	✓	✓	-	-	-	-	-	✓	-	-	✓	-	
	70x70	✓	✓	-	-	-	-	-	✓	-	-	✓	-	
	Ø60	✓	✓	-	-	-	-	-	✓	-	-	✓	-	
Stratifié Moulé Cerclés Rimmed Molded Laminate	30mm Marrakesh Mermer Black Siyah	Ø60	✓	✓	-	-	-	-	✓	-	-	✓	-	
Stratifié Perfect Sense Collection Perfect Sense Laminate	60x60	✓	✓	-	-	-	-	-	✓	-	-	✓	-	
	70x70	✓	✓	-	-	✓	-	-	✓	-	-	✓	-	
	20mm Noir - Black	120x70	-	-	-	✓	-	-	-	-	✓	-	✓	
Stratifié Original Collection Original Collection Laminate	60x60	✓	✓	-	-	-	-	-	✓	-	-	✓	-	
	70x70	✓	✓	-	-	✓	-	-	✓	-	-	✓	-	
	24mm Noyer - Walnut Marbre Samas - Samas Marble Marmara Marbre Blanc - White Marble	80x80	-	-	✓	-	-	-	-	-	-	-	-	
	60x70	✓	✓	-	-	-	✓	-	✓	✓	-	✓	-	
	110x70	-	-	-	✓	-	-	✓	-	✓	✓	-	✓	
	120x70	-	-	-	✓	-	-	-	-	-	✓	-	✓	
	Stratifié Chêne Halifax Oak Halifax Laminate	120x80	-	-	-	✓	-	-	-	-	-	✓	-	✓
	24mm & 46mm Chêne Halifax Naturel Chêne Halifax Tabac	Ø70	✓	✓	-	-	-	-	✓	-	-	✓	-	
Ø120	-	-	✓	-	-	-	-	-	-	-	-	-		
Mélaminé Melamine	60x60	✓	✓	-	-	-	-	-	✓	-	-	✓	-	
	18mm	70x70	✓	✓	-	-	✓	-	✓	-	-	✓	-	
	Minnesota Oak Chocolat Chêne Halifax Naturel	120x70	-	-	-	✓	-	-	-	-	✓	-	✓	
Chêne Odense Oak Odense	60x60	✓	✓	-	-	-	-	-	✓	-	-	✓	-	
	70x70	✓	✓	-	-	-	-	-	✓	-	-	✓	-	
	30mm	120x70	-	-	-	✓	-	-	-	-	✓	-	✓	

Correspondance Pieds/Plateaux

Matching table tops and bases

Piètements Intérieurs Indoor Table Bases		Prato 15	Prato 20	Prato 15 Bar	Prato 70	Rome 05	Rome 06	Rome 05 Bar	Rome 12	Rome 13	Rome 12 Bar	
Compact Easy 12mm	65x65	-	✓	-	-	-	✓	-	✓	-	✓	
Stratifié Moulé Classic 32mm	60x60	✓	✓	✓	-	✓	-	✓	✓	-	✓	
	70x70	-	✓	-	-	-	✓	-	✓	-	✓	
	Basalt Haussmann Granit Light	✓	✓	✓	-	✓	-	✓	✓	-	✓	
Avalon Pine Irony Malaga	✓	✓	✓	-	✓	-	✓	✓	-	✓		
Stratifié Moulé Cerclés Rimmed Molded Laminate	30mm	✓	✓	✓	-	✓	-	✓	✓	-	✓	
Marrakesh Mermer Black Siyah	Ø60	✓	✓	✓	-	✓	-	✓	✓	-	✓	
Stratifié Perfect Sense Collection Perfect Sense Laminate	60x60	✓	✓	✓	-	✓	-	✓	✓	-	✓	
	70x70	-	✓	-	-	-	✓	-	✓	-	✓	
	20mm	-	-	-	-	-	-	-	-	✓	-	
Noir - Black	120x70	-	-	-	-	-	-	-	✓	-	-	
Stratifié Original Collection Original Collection Laminate	60x60	✓	✓	✓	-	✓	-	✓	✓	-	✓	
	70x70	-	✓	-	-	-	✓	-	✓	-	✓	
	24mm	-	✓	-	✓	-	✓	-	✓	-	-	
	Noyer - Walnut Marbre Samas - Samas Marble Marmara Marbre Blanc - White Marble	60x70	-	✓	-	-	-	✓	-	✓	✓	✓
	110x70	-	-	-	-	-	-	-	-	✓	-	
Stratifié Chêne Halifax Oak Halifax Laminate	120x70	-	-	-	-	-	-	-	-	✓	-	
	120x80	-	-	-	-	-	-	-	-	✓	-	
	24mm & 46mm	✓	✓	✓	✓	✓	✓	✓	✓	✓	✓	
Chêne Halifax Naturel Chêne Halifax Tabac	Ø70	✓	✓	✓	✓	✓	✓	✓	✓	✓	✓	
Ø120	-	-	-	✓	-	✓	-	-	-	-	-	
Mélaminé Melamine	60x60	✓	✓	✓	-	✓	-	✓	✓	-	✓	
	18mm	-	✓	-	-	-	✓	-	✓	-	✓	
	Minnesota Oak Chocolat Chêne Halifax Naturel	120x70	-	-	-	-	-	-	-	✓	-	
Chêne Odense Oak Odense	60x60	✓	✓	✓	-	✓	-	✓	✓	-	✓	
	70x70	-	✓	-	-	-	✓	-	✓	-	✓	
	30mm	-	-	-	-	-	-	-	-	✓	-	
120x70	-	-	-	-	-	-	-	-	✓	-		

Pièces détachées

Spare parts

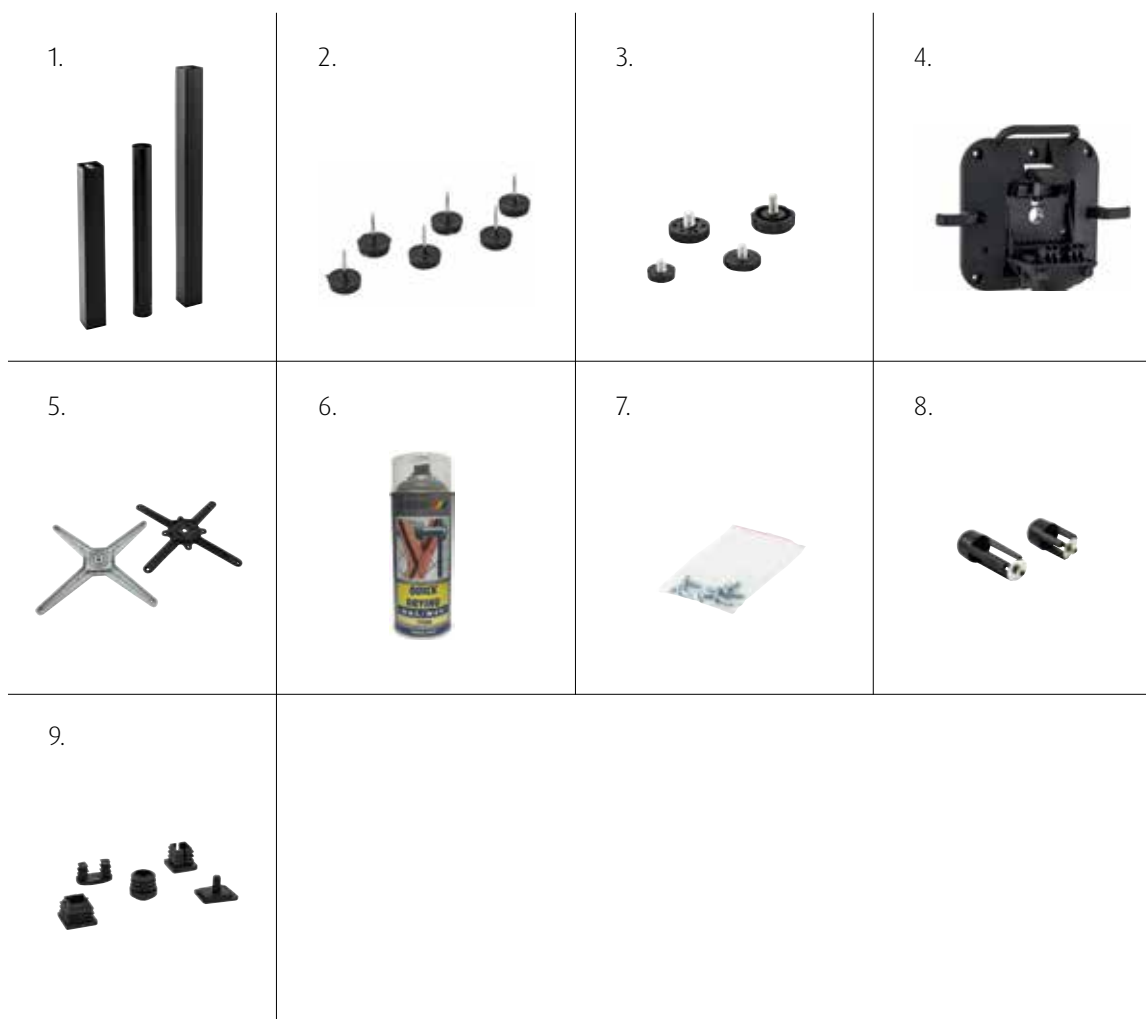

1. Tubes métalliques pour piètements intérieurs. *Metal tubes for indoor table bases.* 2. Patins en nylon à clouer pour mobilier en bois. *Nylon gliders for wooden furniture.* 3. Vérins de réglage pour piètements. *Table bases plugs.* 4. Modena Système basculant. *Modena fliptop system.* 5. Croix de fixation pour piètements. *Cross for table bases.* 6. Bombe aérosol de couleur pour la gamme Bastille & Pigalle - 400ml. *Colour spray can for the Bastille & Pigalle range - 400ml.* 7. Vis de montage pour plateaux de table. *Screws for tables tops.* 8. Empire éléments de fixation. *Assembly parts for the Empire table.* 9. Bouchons PVC pour mobilier intérieur et extérieur. *PVC plugs for outdoor and indoor furniture.*

























Vidéos de montage

























Assembly videos



Retrouvez nos vidéos de montage via ce QR code.
Find our assembly videos via this QR code.



















































 <p>New</p> <p>Loom p10</p>	 <p>New</p> <p>Loyd p12</p>	 <p>New</p> <p>Metz p14</p>	 <p>New</p> <p>Dax p16</p>	 <p>Orléans p18</p>
 <p>Rochelle p20</p>	 <p>Brest p22</p>	 <p>Laval p24</p>	 <p>Murcia p26</p>	 <p>Cadix p28</p>
 <p>New</p> <p>Denia p30</p>	 <p>New</p> <p>Alicante p32</p>	 <p>New</p> <p>Javea p34</p>	 <p>Amsterdam p36</p>	 <p>Breda p38</p>
 <p>Stock Limité Limited Stock</p> <p>Savana p40</p>	 <p>New</p> <p>Saint-Raphaël p42</p>	 <p>Stock Limité Limited Stock</p> <p>Concorde p44</p>	 <p>New</p> <p>Odéon p46</p>	 <p>New</p> <p>Bercy p48</p>
 <p>New</p> <p>Limogés p50</p>	 <p>Reims p52</p>	 <p>Blois p54</p>	 <p>Dole p56</p>	 <p>New</p> <p>Paris p58</p>

 <p>Montmartre p60</p>	 <p>Stock limité Limited Stock Drouot p62</p>	 <p>Trocadero p64</p>	 <p>Stock limité Limited Stock Villette p66</p>	 <p>Stock limité Limited Stock Madeleine p68</p>
 <p>Stock limité Limited Stock Dauphine p70</p>	 <p>New Bastille p72</p>	 <p>New Bastille Bst p74</p>	 <p>New Pigalle p76</p>	
 <p>New Doha p78</p>	 <p>New Cairo p80</p>	 <p>Dubai p82</p>	 <p>Jeddah p84</p>	 <p>Oman p86</p>
 <p>Penelope p88</p>	 <p>Ulysse p90</p>	 <p>New Achille Bar 75 p92</p>	 <p>Tom Bar 75 p94</p>	 <p>Monna p96</p>
 <p>Sky Pro p98</p>	 <p>Maya p100</p>	 <p>Maya Bar 75 p102</p>	 <p>Atlantic p104</p>	 <p>Marcel p106</p>

				
Marcel XL p108	Marcel Bar 75 p110	Daytona p112	Panama p114	Jamaica p116
				 New
Jamaica F p118	Jamaica Bst p120	Kys p122	Kys Bar p124	Modena 3 p126
 New	 New	 New	 New	 New
Modena Double p126	Modena 4 p127	Modena 4 Bar p127	Kyoto 4 p128	Kyoto Bar p128
				
Monza p130	Monza Bar p130	Berlin 2 p132	Berlin 4 p132	Berlin 4 Bar p133
				
Empire 3 p134	Empire 4 p134	Empire 4 Bar p134	Empire 2 p135	Empire Grande p135

 <p>Bistrot 3 H43 p136</p>	 <p>Bistrot 3 p136</p>	 <p>Bistrot 4 p137</p>	 <p>Bistrot 3 Bar p137</p>	 <p>Orsay p128</p>
<p>New</p>  <p>Compact Easy 12 mm p140</p>	<p>New</p>  <p>Stratifié Moulé Classic p142</p>	 <p>Stratifié Moulé Cerclé p144</p>		

 <p>New</p> <p>Eloise p148</p>	 <p>New</p> <p>Romeo p150</p>	 <p>New</p> <p>Tristan Bst p152</p>	 <p>New</p> <p>Clothilde p154</p>	 <p>New</p> <p>Ginette p156</p>
 <p>New</p> <p>Angèle p158</p>	 <p>New</p> <p>Marius Bst p160</p>	 <p>New</p> <p>Eugénie p162</p>	 <p>Simone p164</p>	 <p>René p166</p>
 <p>Auguste p168</p>	 <p>Mélina p170</p>	 <p>Sandra p172</p>	 <p>Noélia p174</p>	 <p>Zoé p176</p>
 <p>Ralph p178</p>	 <p>Mikka p180</p>	 <p>Olaf p182</p>	 <p>Jacob p184</p>	 <p>Kyle p186</p>
 <p>Wendy p188</p>	 <p>Maurice p190</p>	 <p>Maurice Bst p192</p>	 <p>College p194</p>	 <p>New</p> <p>Harvard p196</p>

				
Montréal p198	Stanley p200	Stanley Bst p202	Brixton p204	Soho p206
 <small>Stock Limité limited stock</small>				
Condor p208	Cuba p210	Cuba Double p212	Kate p214	Budapest p216
				
Budapest Bst p218	Dimitri p220	Dimitri Bst p222	Brooklyn p224	Brooklyn Bst p226
		 <small>New</small>	 <small>New</small>	
Pub p228	Pub Bst p230	Palma p232	Palma Bst p234	Sofia p236
				 <small>Stock Limité limited stock</small>
Sofia Bst p238	Emile p240	Alfonse p242	Oscar Bst p244	Lautrec S p246

				
Arnold p248	Willy p250	Floriane II p252	Floriane Bst II p254	Clinton p256
				 New
Clinton Bst p258	Maryne p260	Jolyne p262	Ellen p264	Gallia 4 p266
 New	 New	 New	 Stocks Limited Limited Stock	
Gallia 4 Bar p266	Gallia 4 XL p267	Gallia Double p267	Factory p268	Retro Small p269
				
Retro Large p269	Bistro 3 H43 p270	Bistro 3 p270	Bistro 4 p271	Bistro 3 Bar p271
				
Prato 16 p272	Prato 19 p272	Prato 30 p272	Prato 16 Bar p273	Prato 30 Bar p273

				
Prato 15 p274	Prato 15 Bar p274	Prato 20 p275	Prato 70 p275	Rome 05 p276
				
Rome 06 p276	Rome 05 Bar p276	Rome 12 p277	Rome 13 p277	Rome 12 Bar p277
				
Stratifié Original Collection p278	Stratifié Perfect Sense Collection p280	Stratifié Chêne Halifax p282	Mélaminé p284	Odense p286
				
William p288	Jacky p290			

Réception - Catering

				
Tiffany p294	XL 180 p296	Cocktail 80 p297	Osaka p298	Pack Cocktail 80 & Osaka p299

